

bnr 1	bnr 2	bnr 3	bnr 4	bnr 5	bnr 6
Achteraanzicht	R440	R445	R210		R210
R445			R220		R220

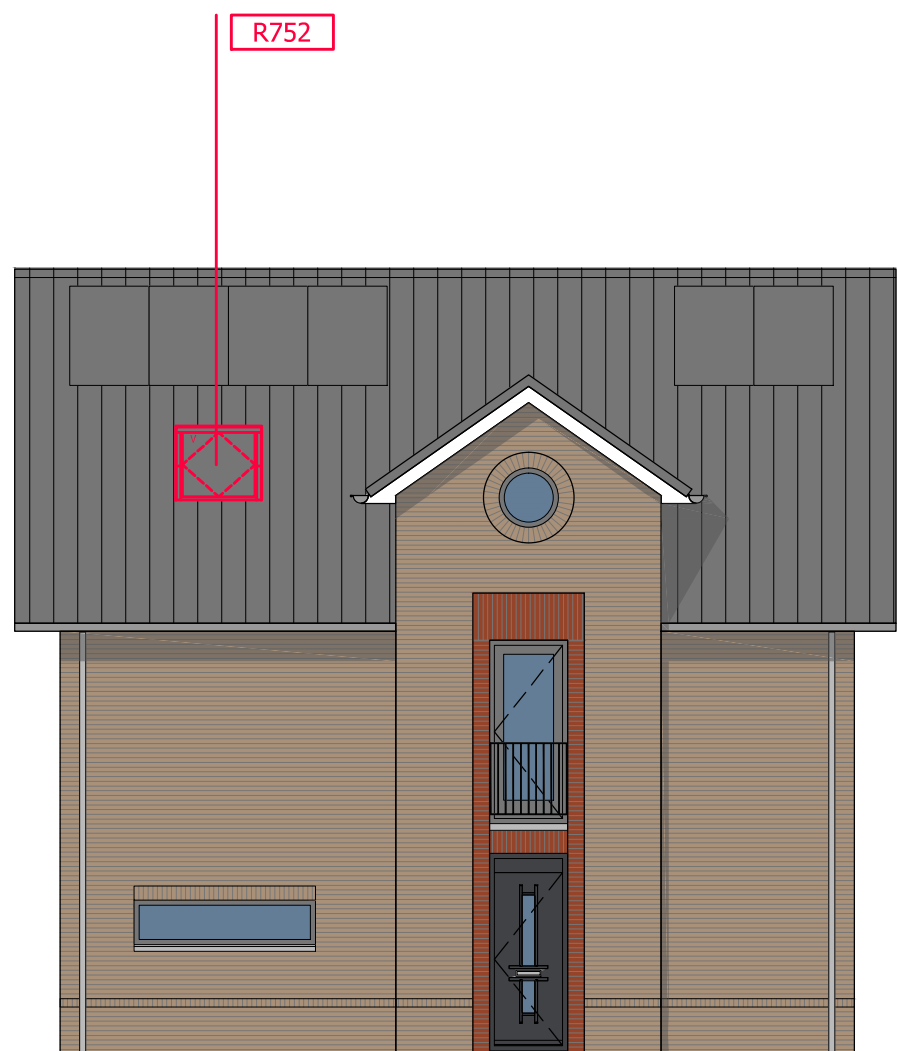

bnr 1

Zijaanzicht

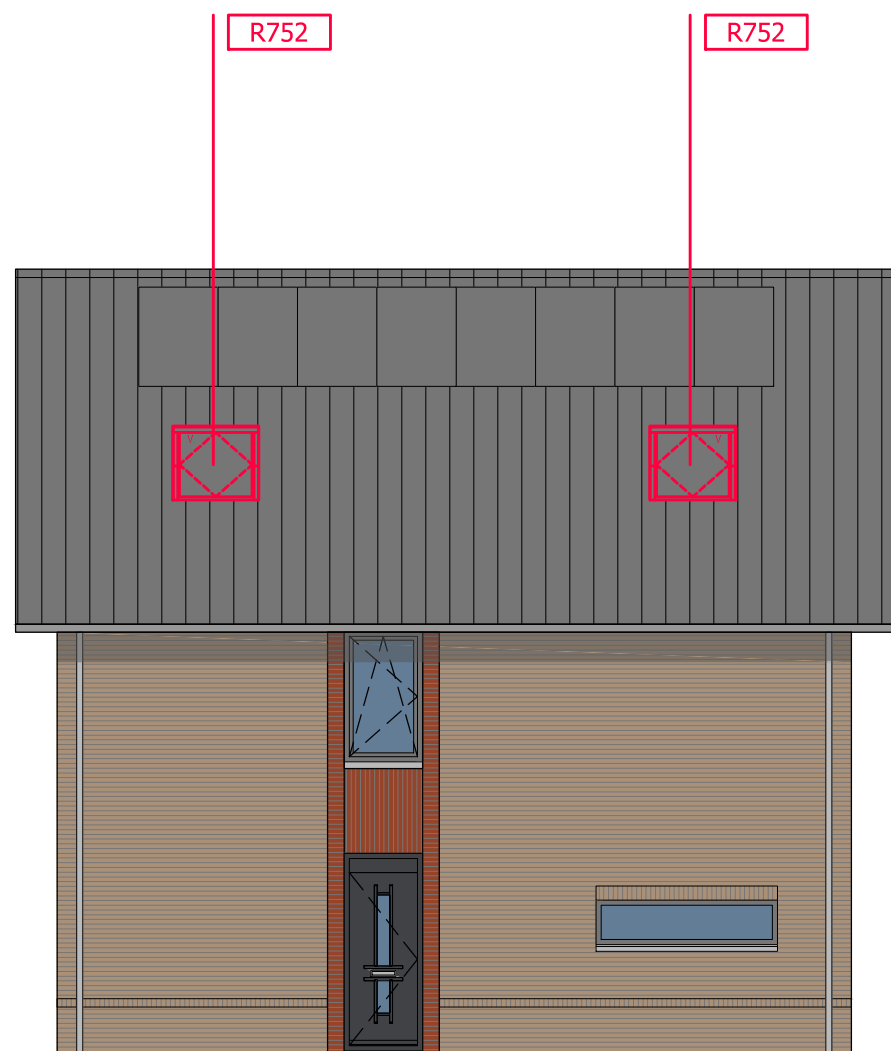

bnr 6

Zijaanzicht

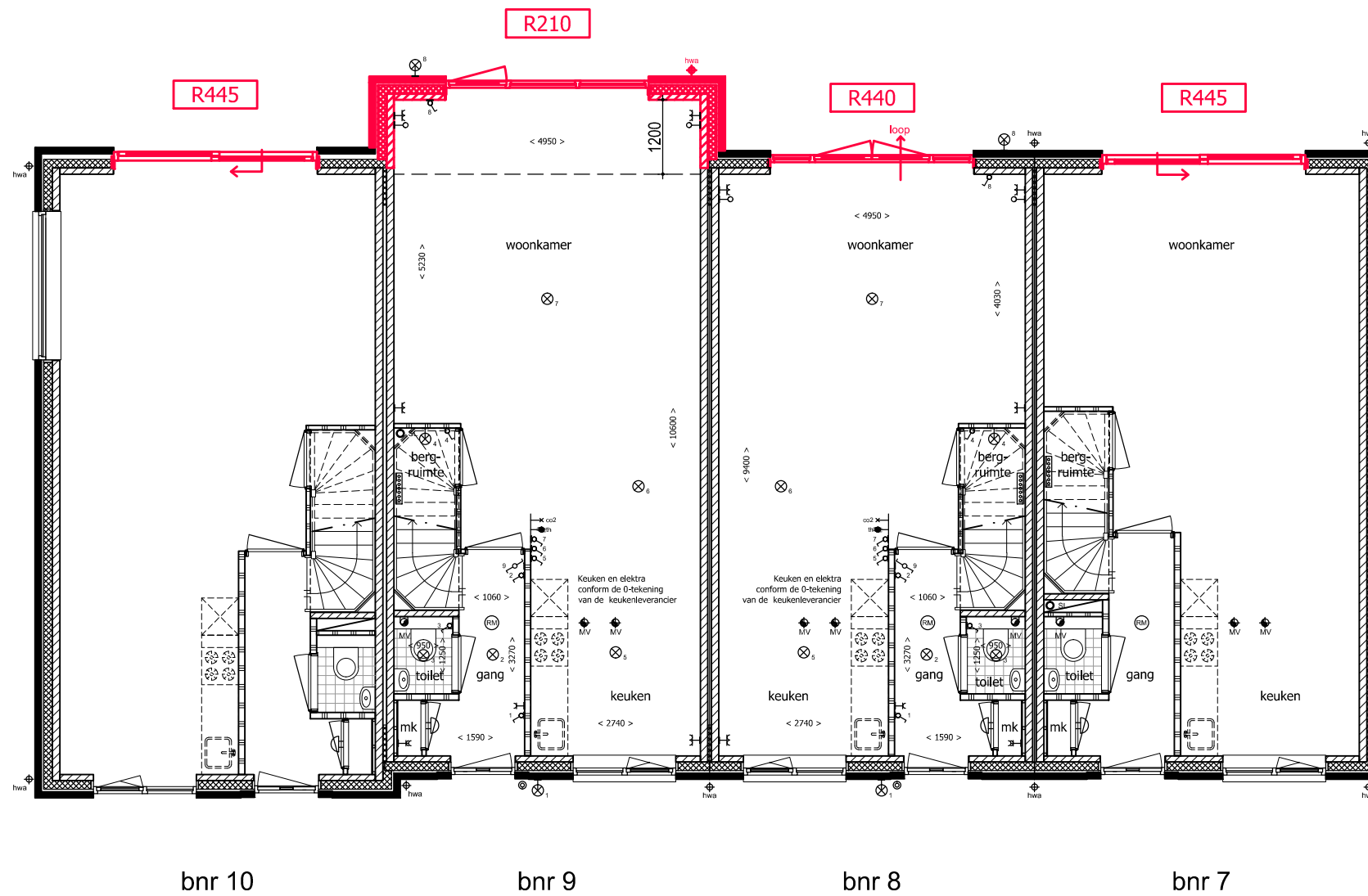

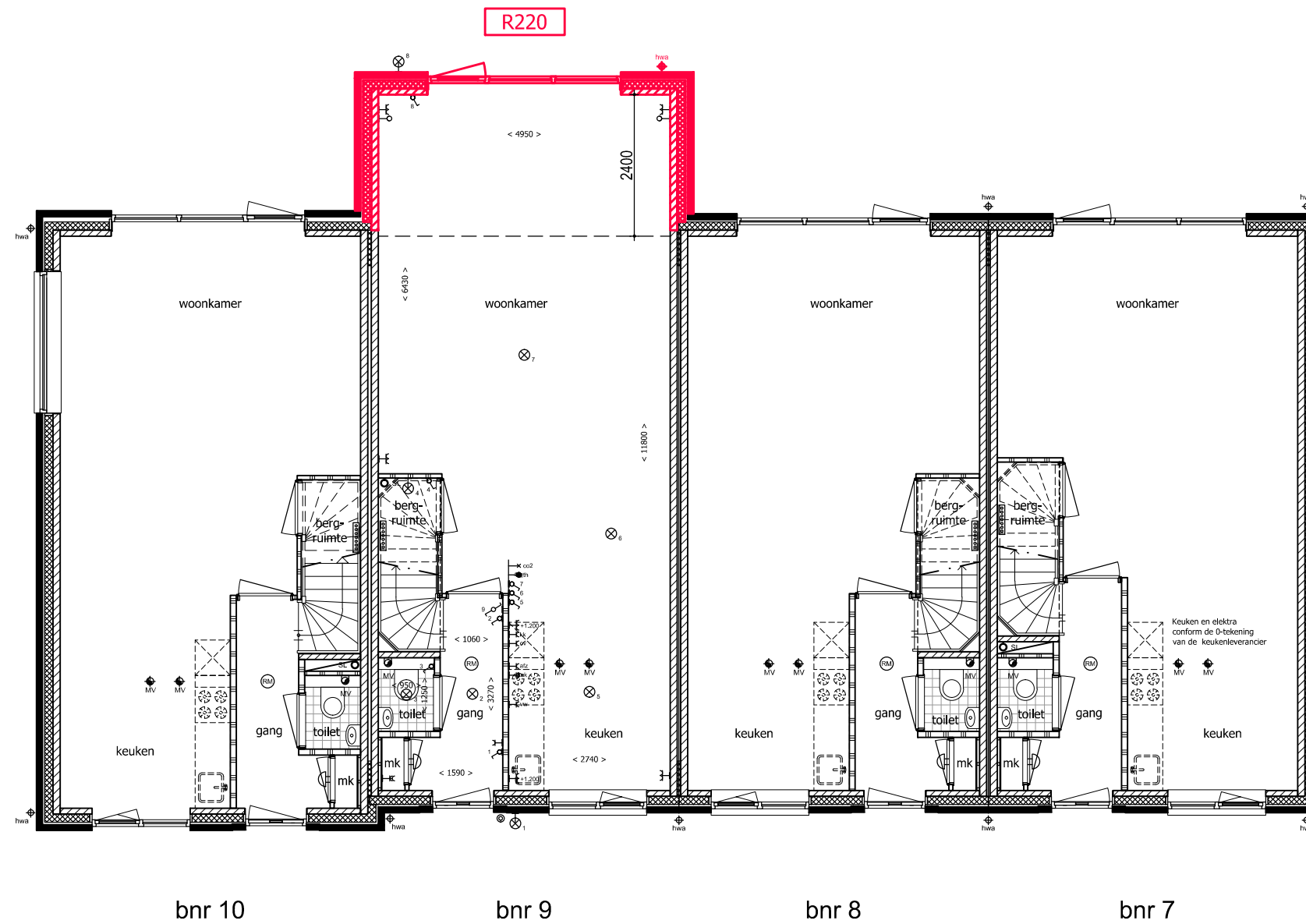

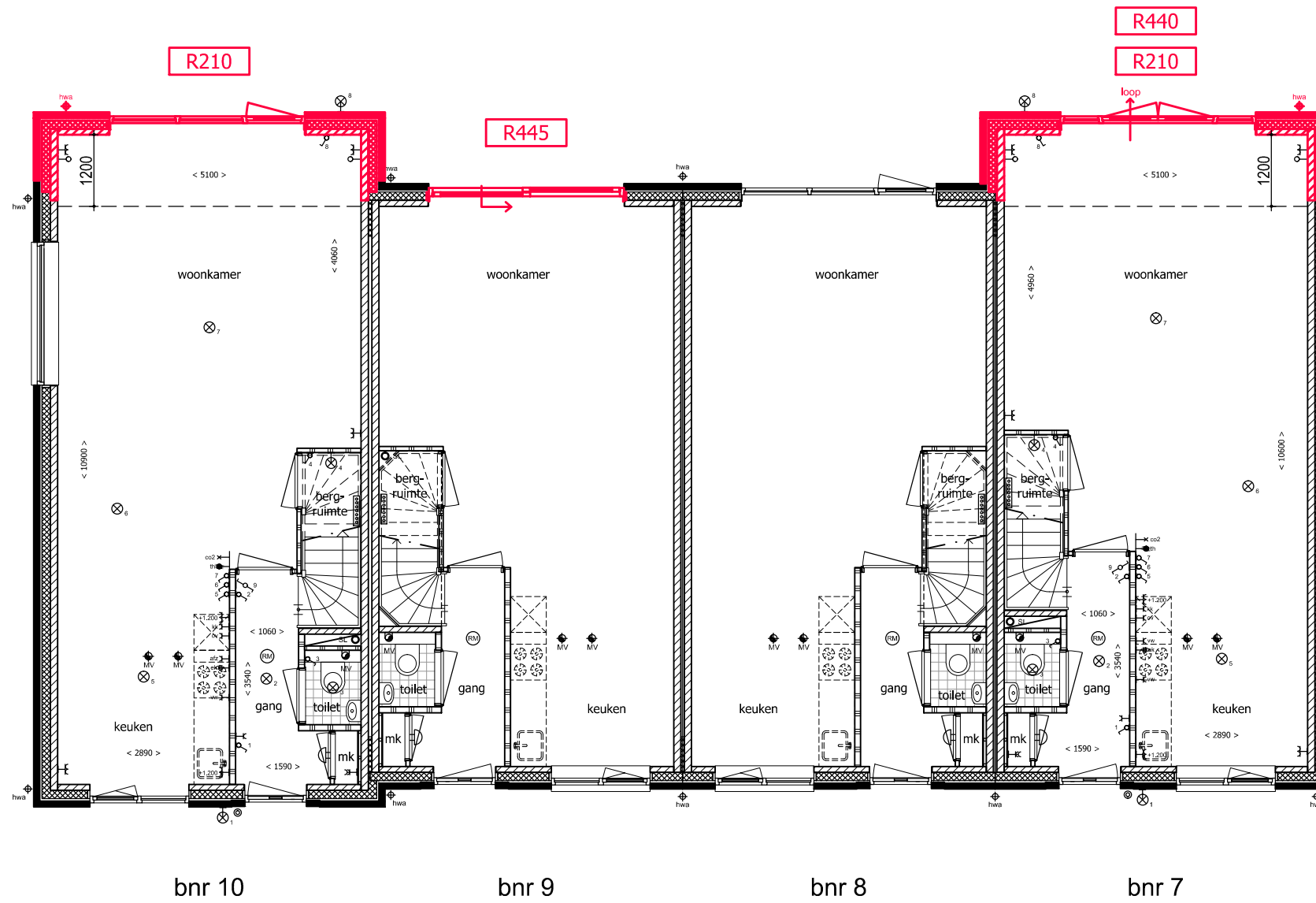

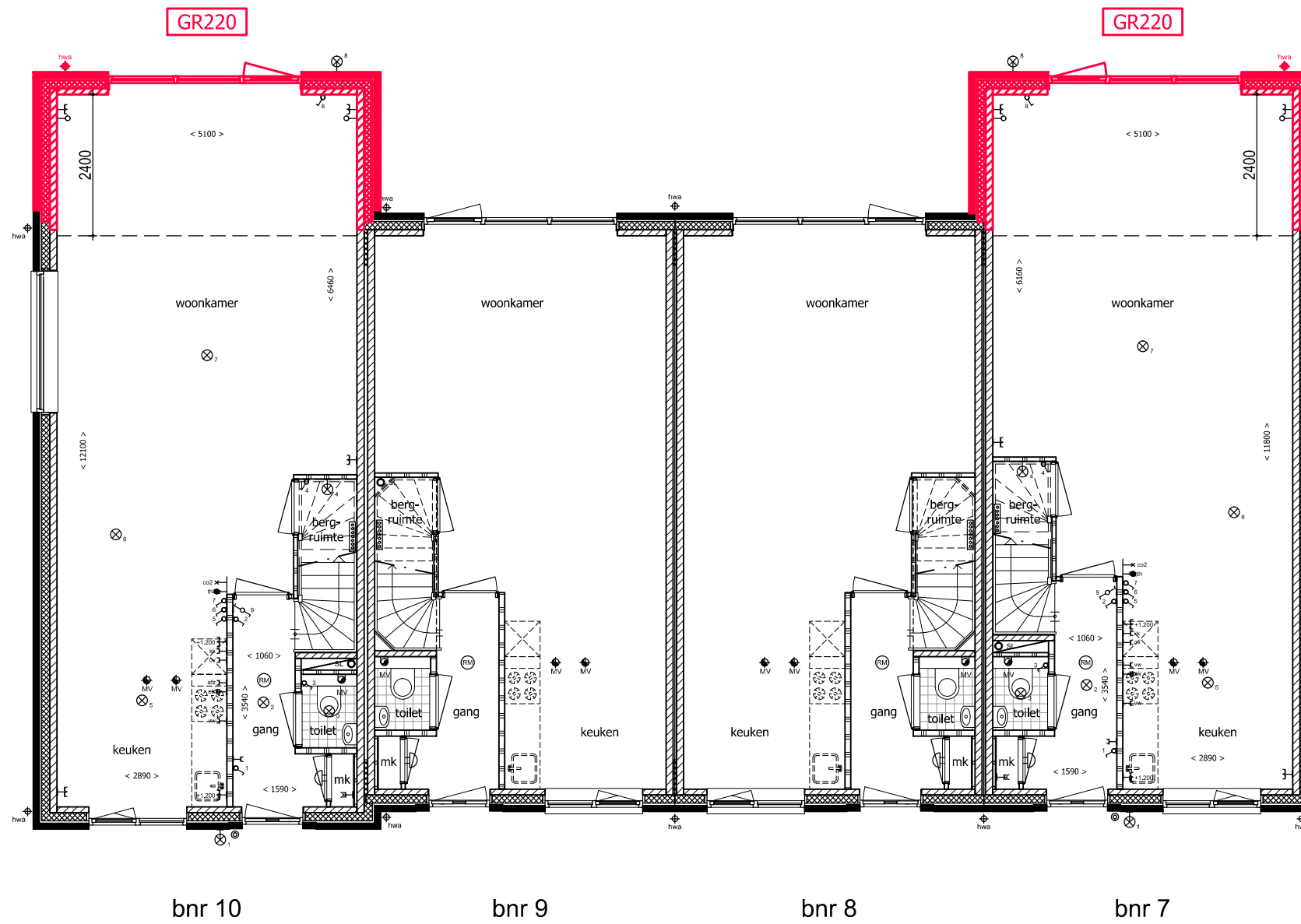

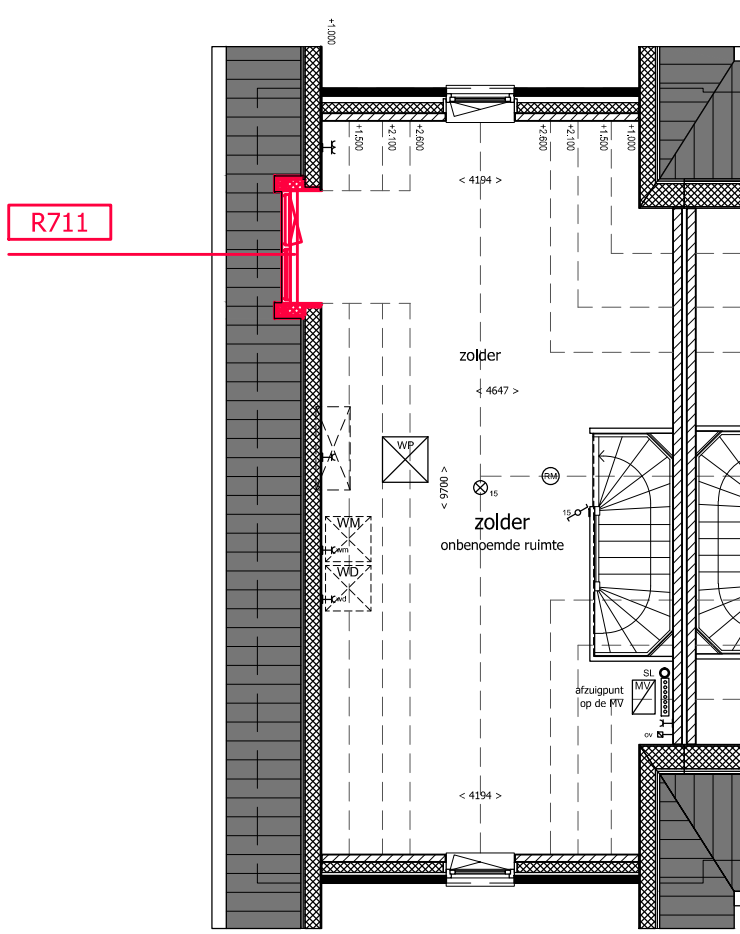

bnr 10

2e Verdieping

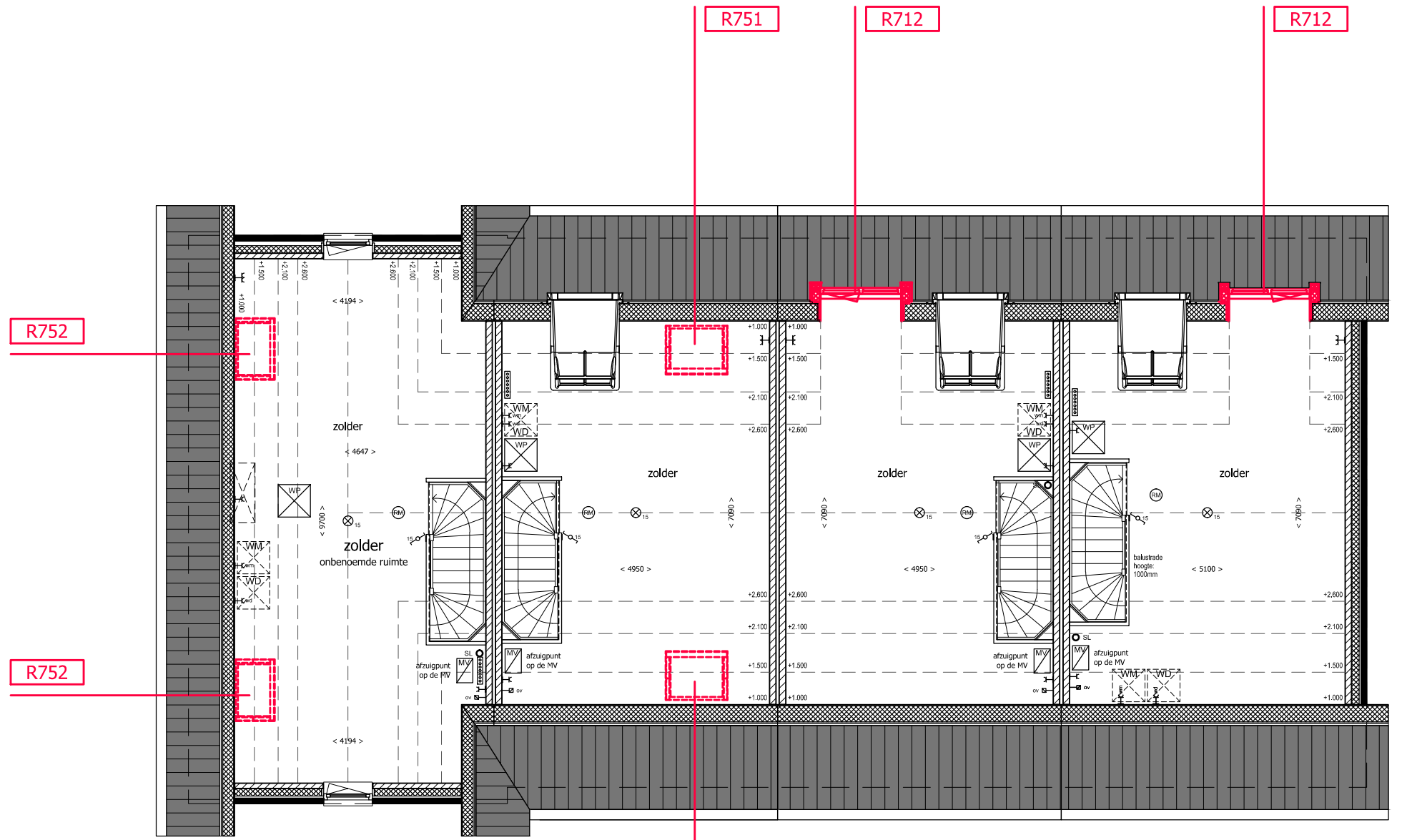

bnr 10

bnr 9

bnr 8

bnr 7



Vooraanzicht

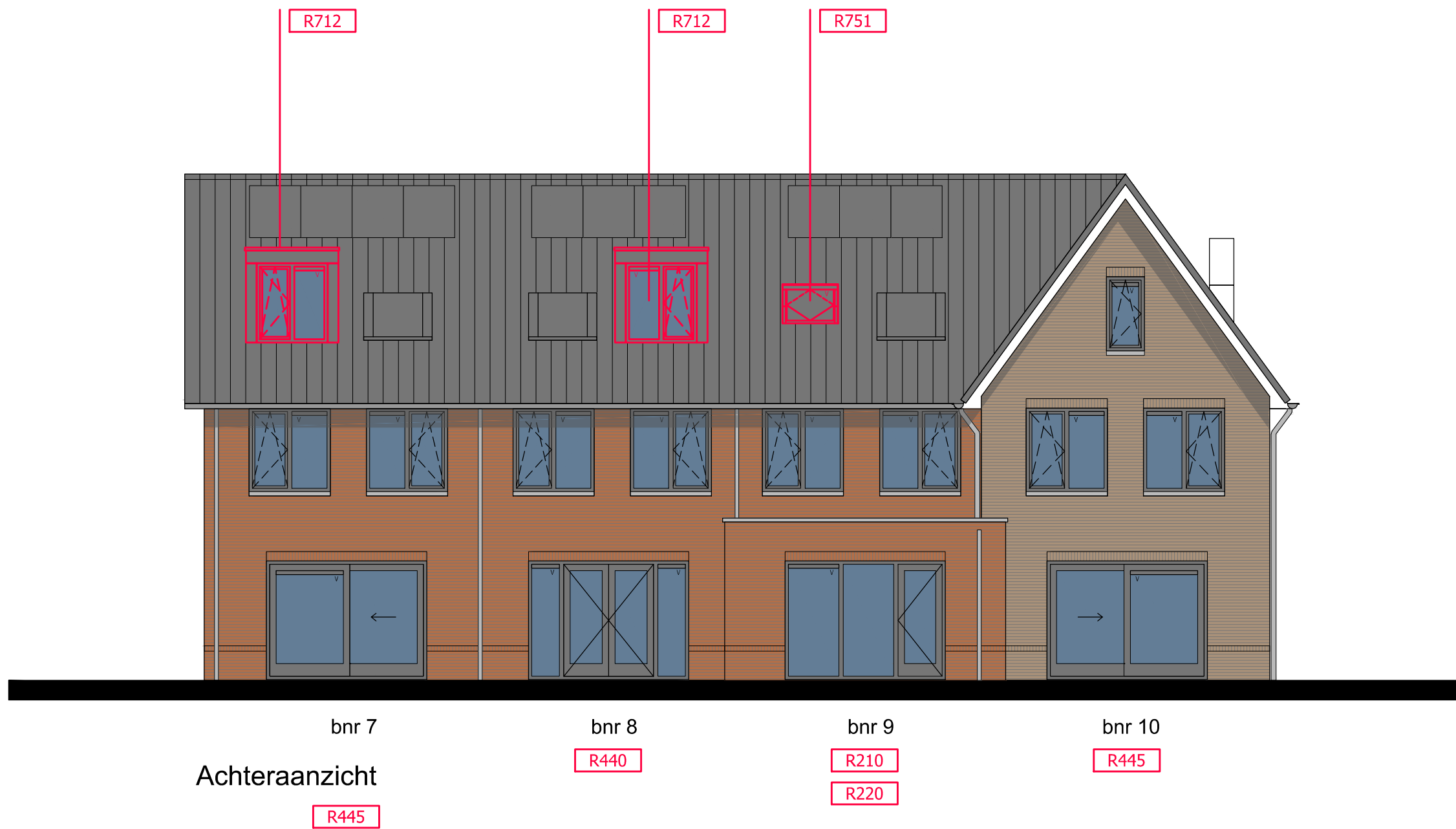



Achteraanzicht

bnr 7

R210

R220

R440

bnr 8

R445

bnr 9

bnr 10

R210

R220

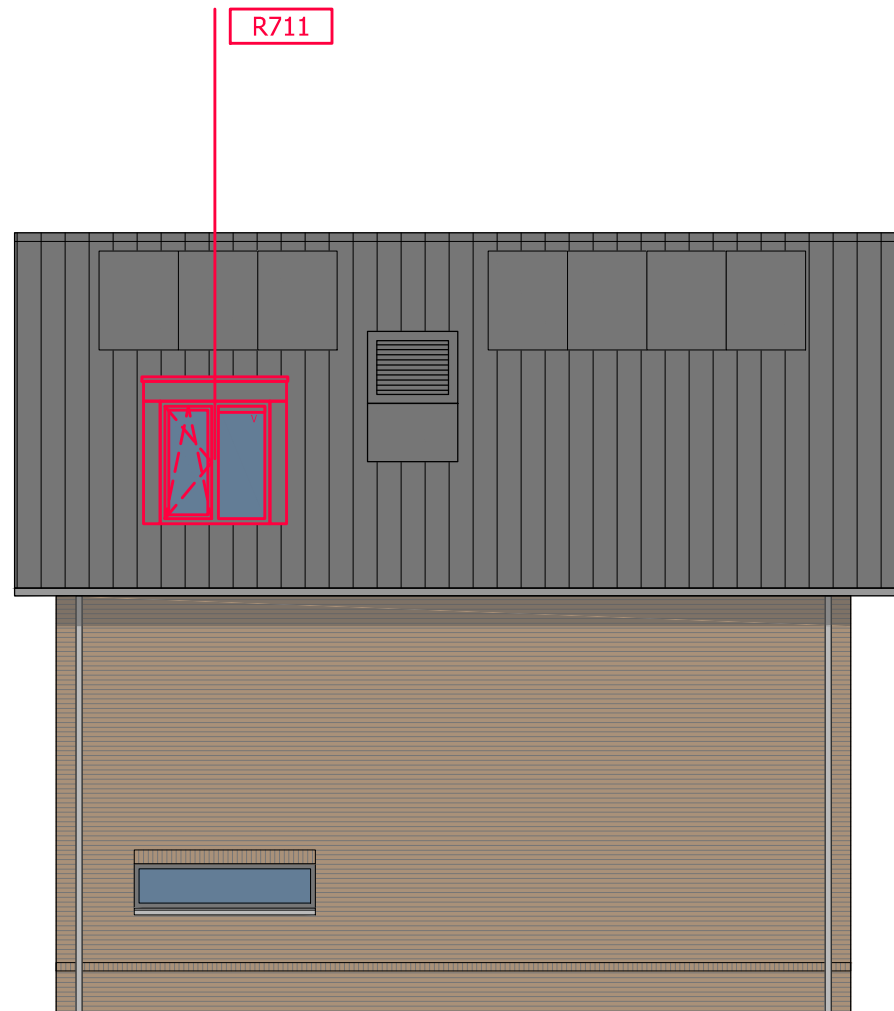

Zijaanzicht

bnr 10

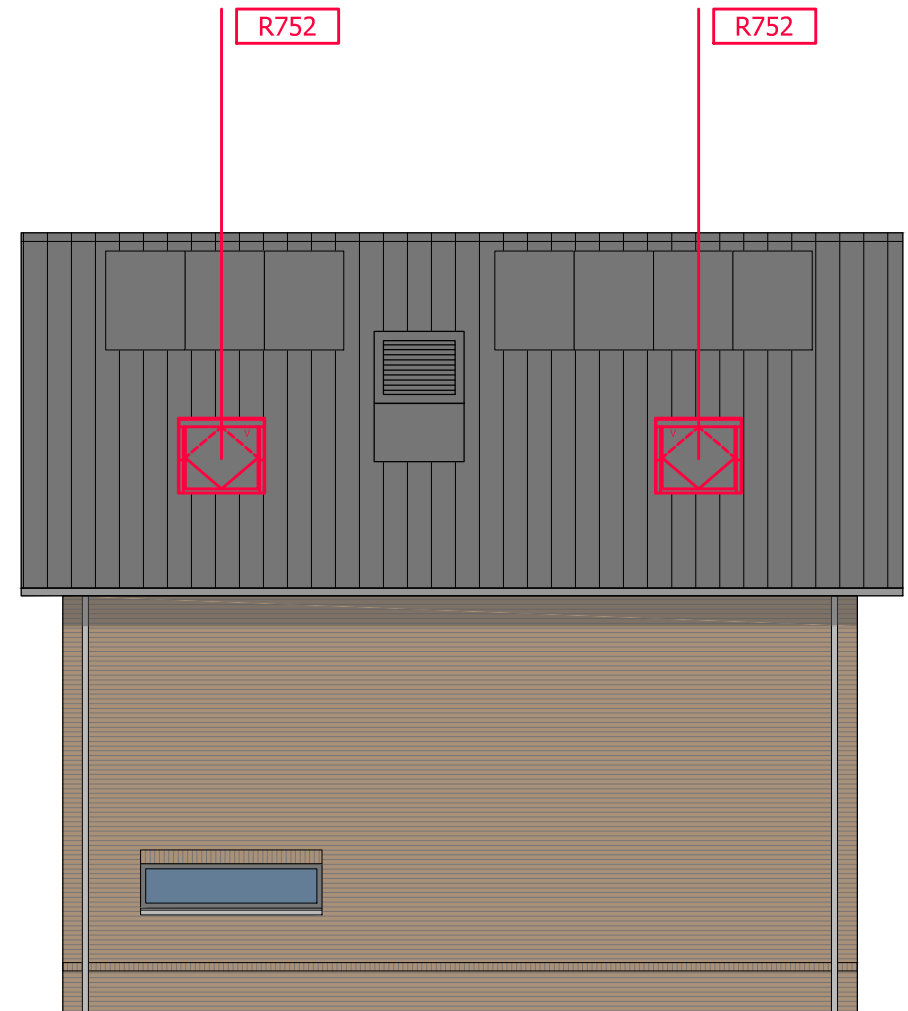

Zijaanzicht

bnr 10

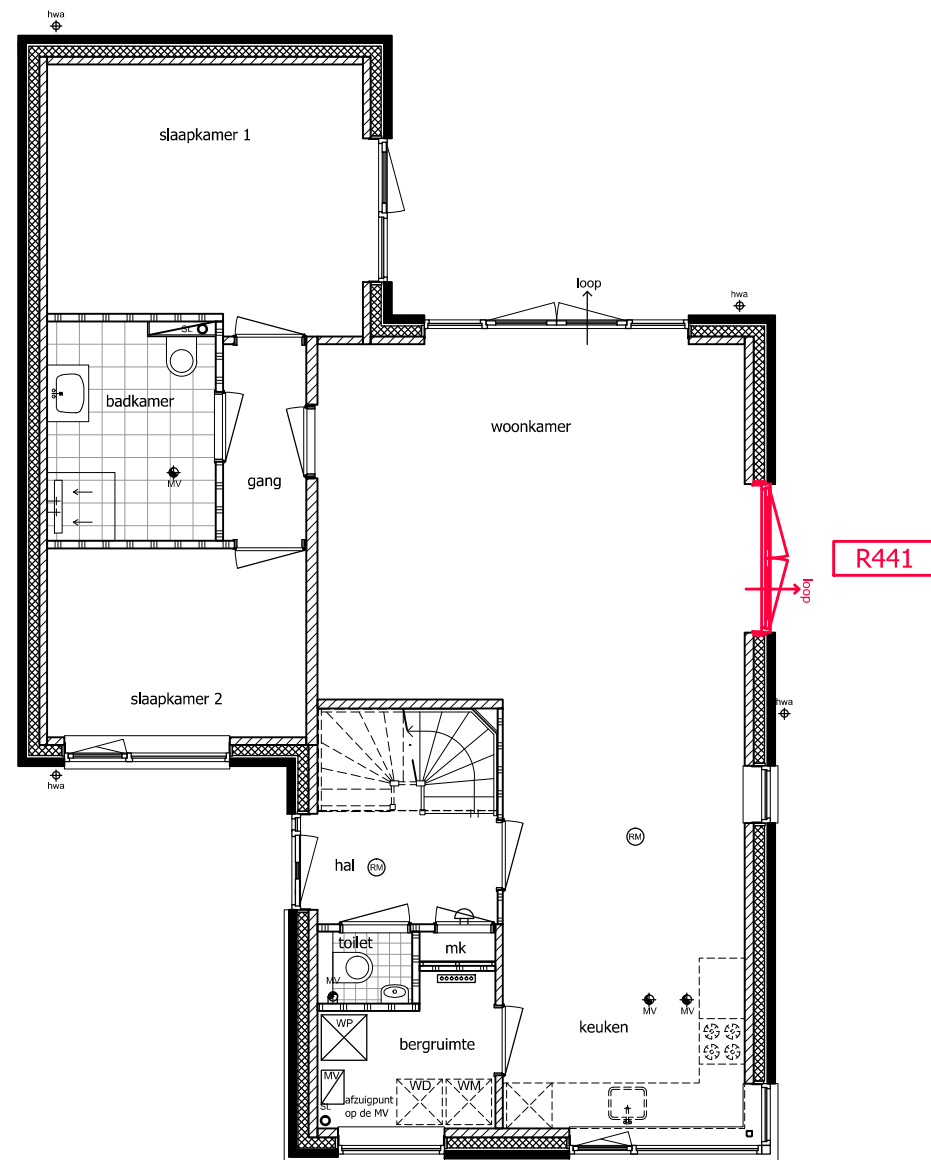

Bnr 11: optie dubbele deur

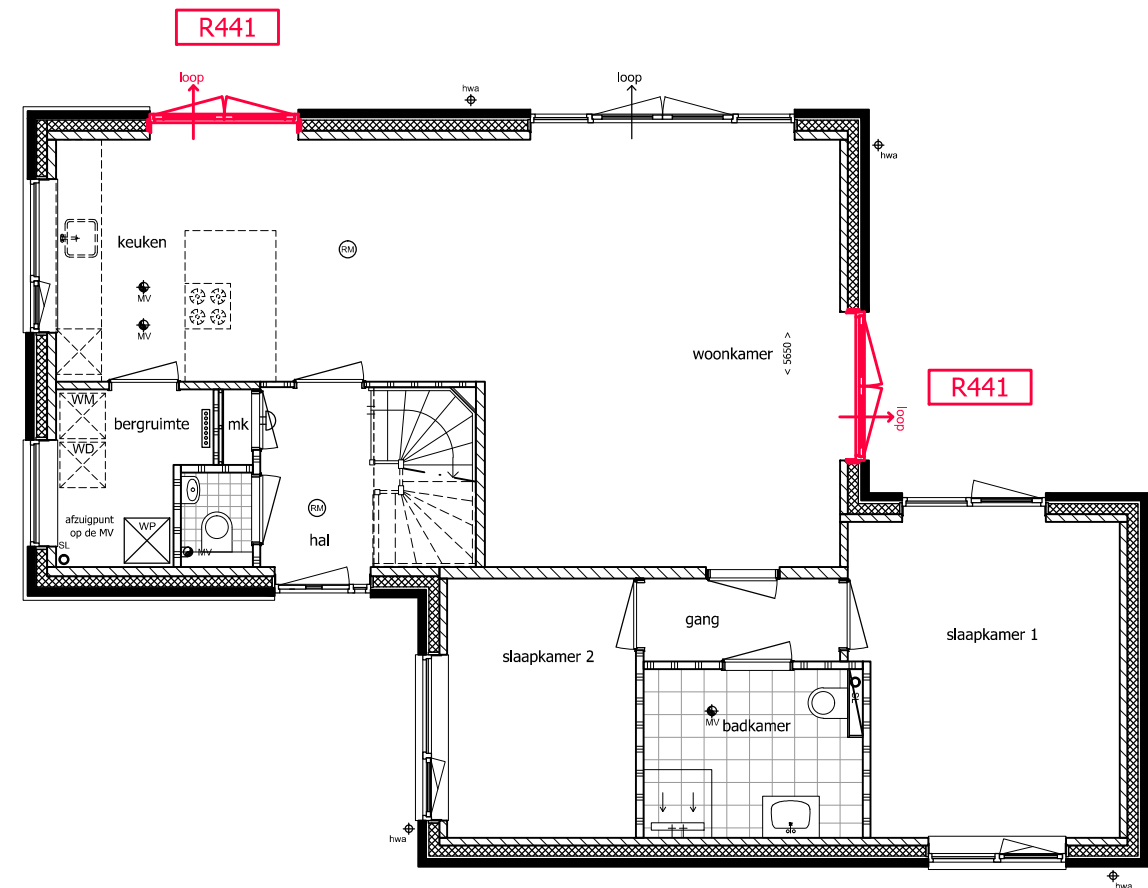

Bnr 12: optie dubbele deuren

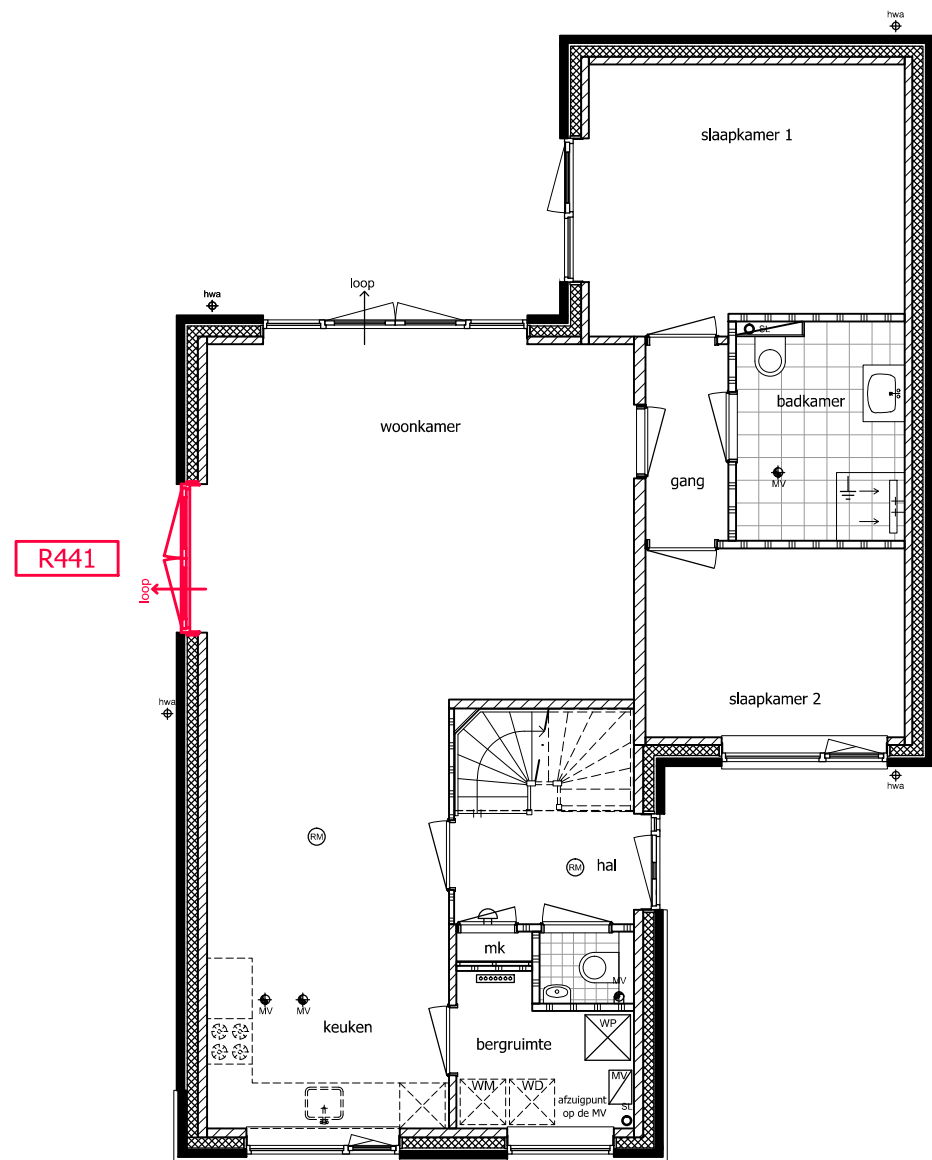

Bnr 13: optie dubbele deur

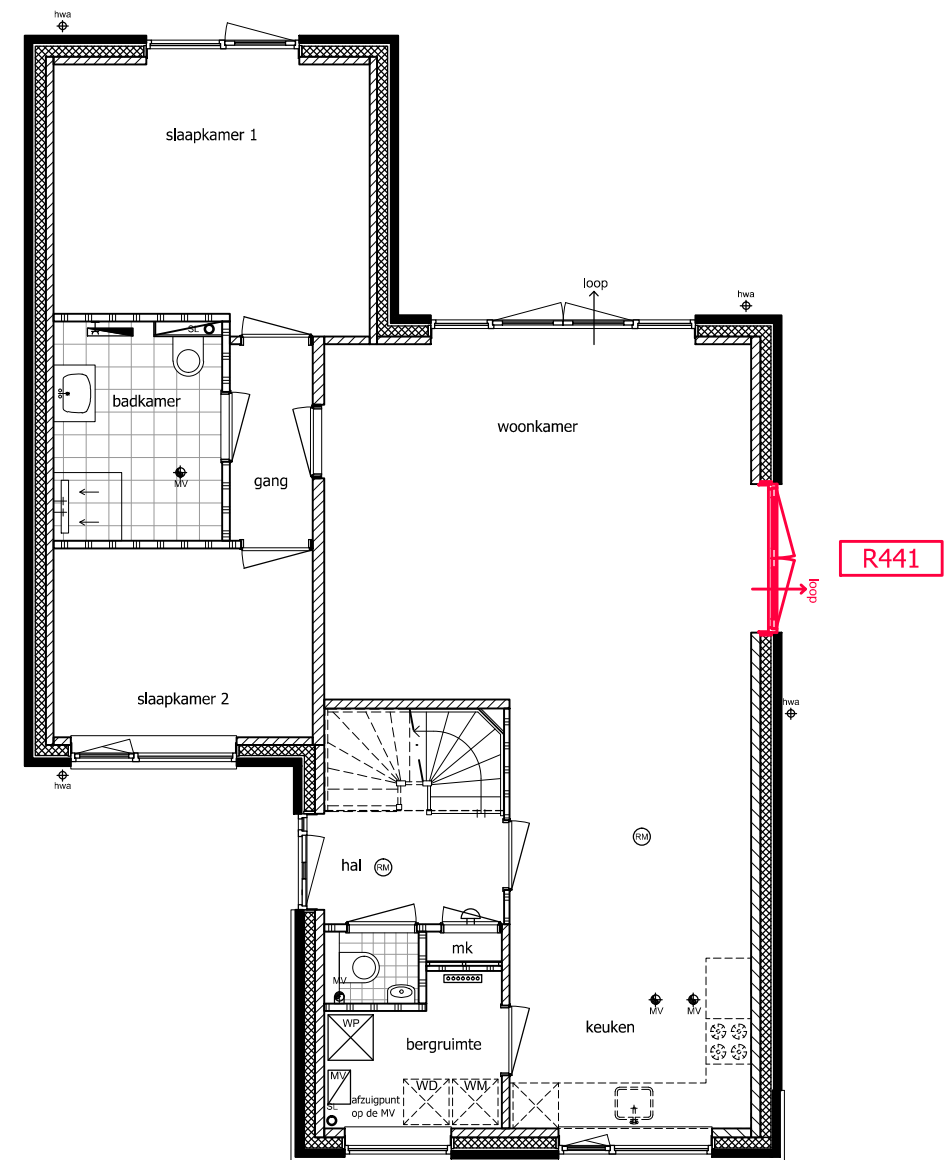

Bnr 14: optie dubbele deur

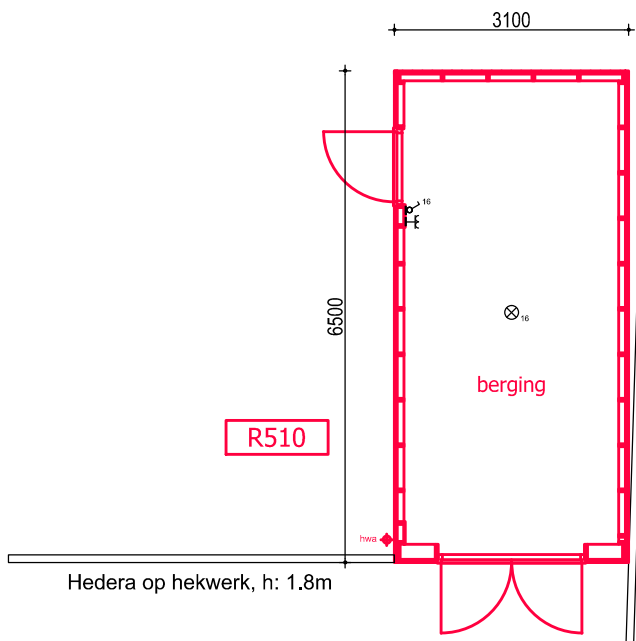
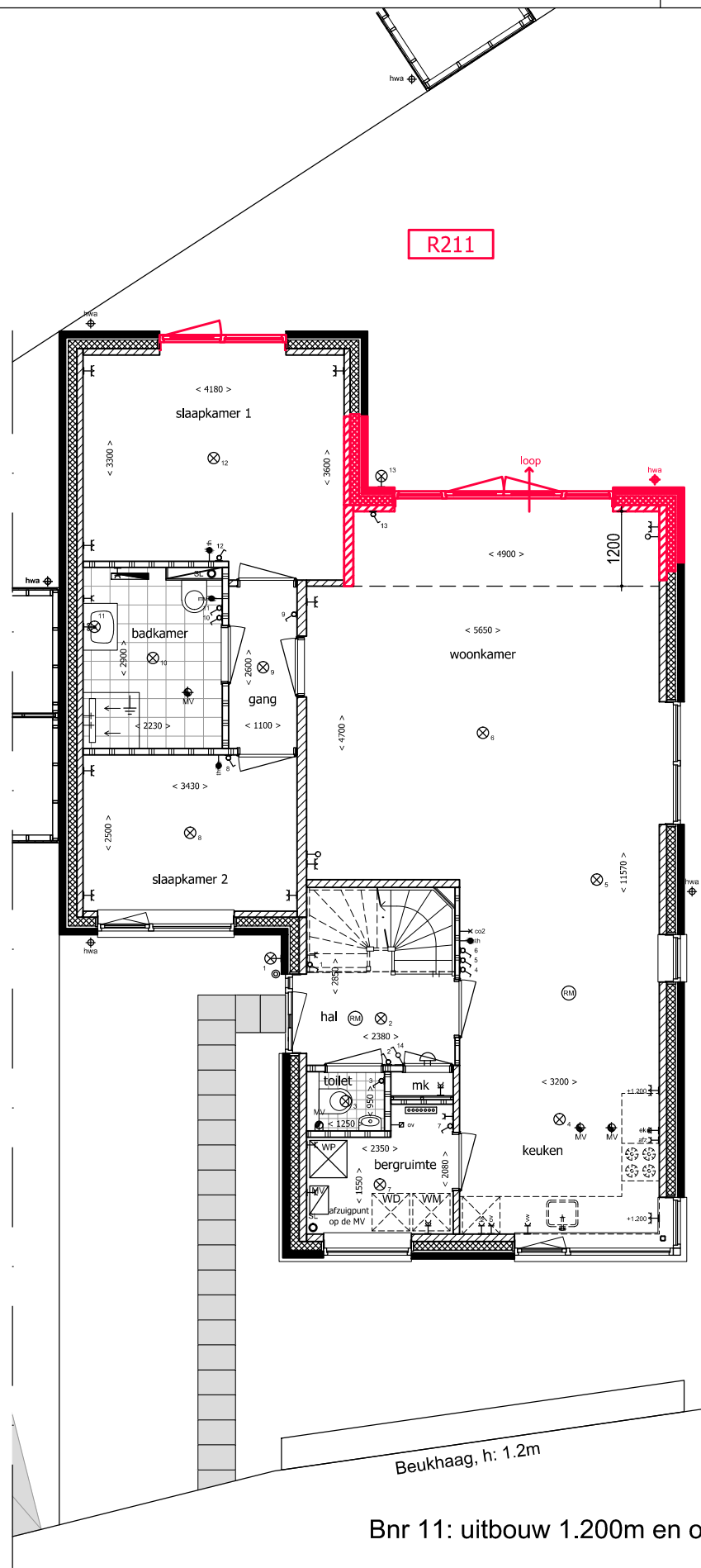

Bnr 11: uitbouw 1.200m en optie grotere berging

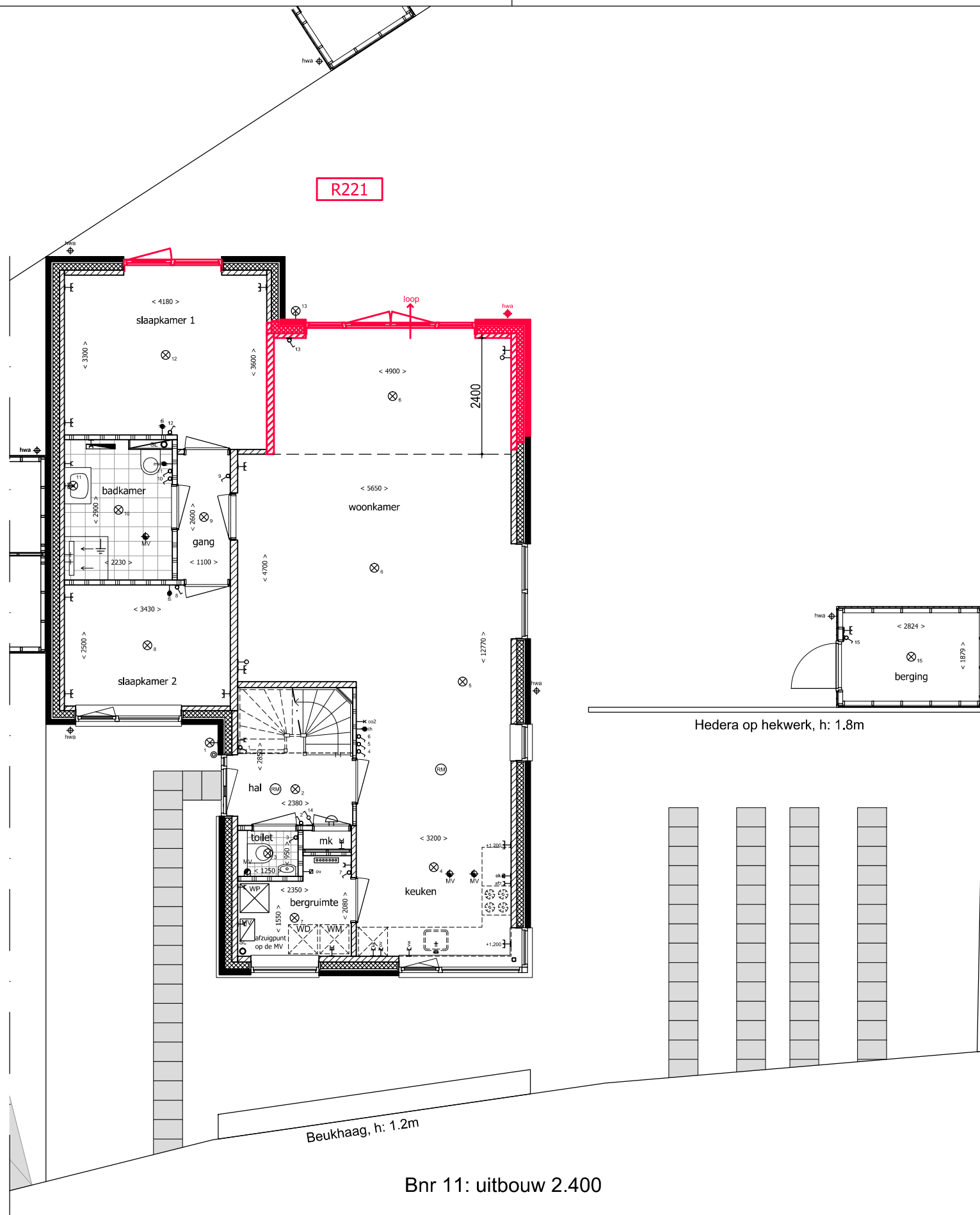

Hedera op hekwerk, h: 1.8m

Hedera op hekwerk, h: 1.8m

Hedera op hekwerk, h: 1.8m

Begane grond

Beukhaag, h: 1.2m

Bnr 11: uitbouw 2.400

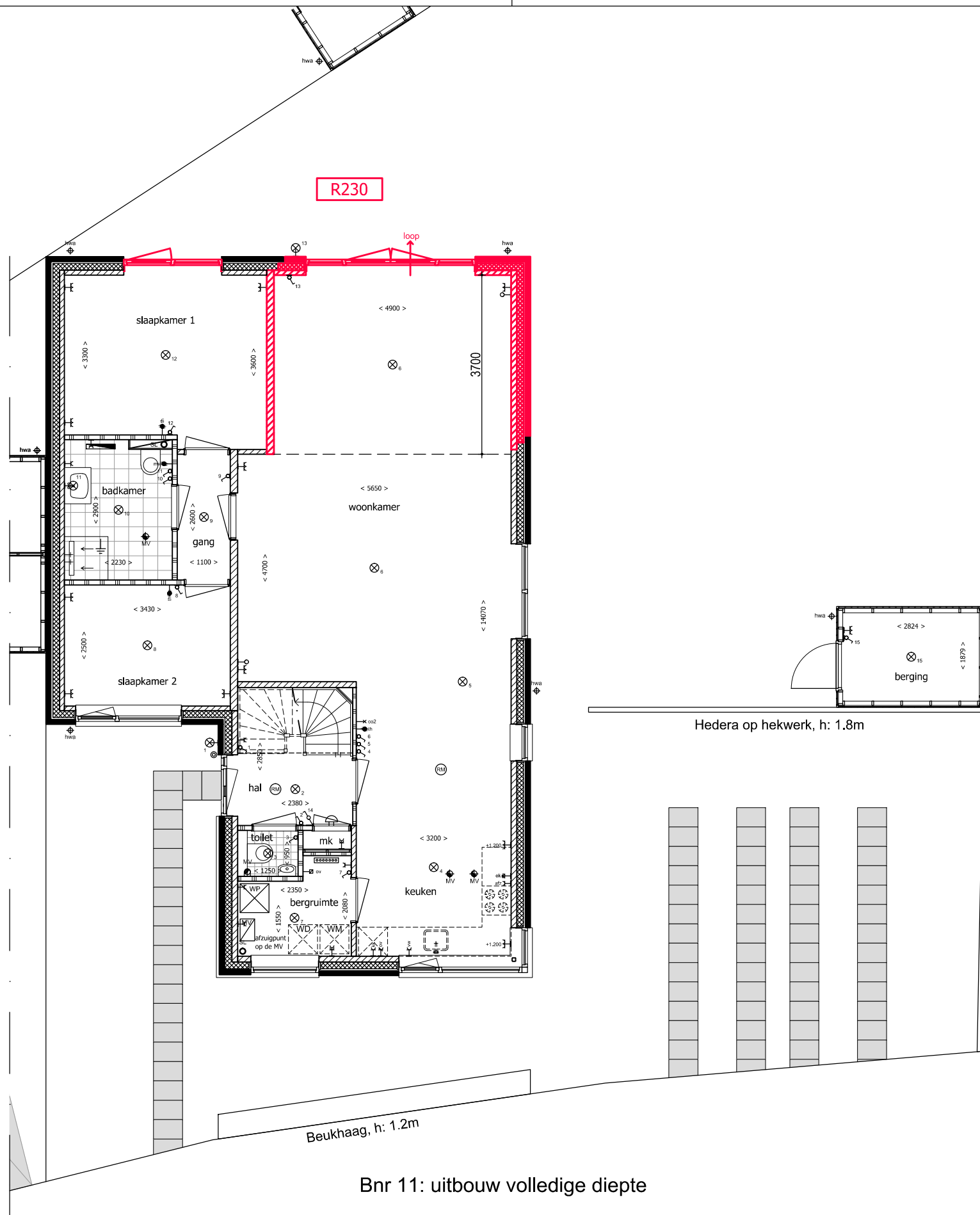

Hedera op hekwerk, h: 1.8m

Hedera op hekwerk, h: 1.8m

Hedera op hekwerk, h: 1.8m

Begane grond

Beukhaag, h: 1.2m

Bnr 11: uitbouw volledige diepte

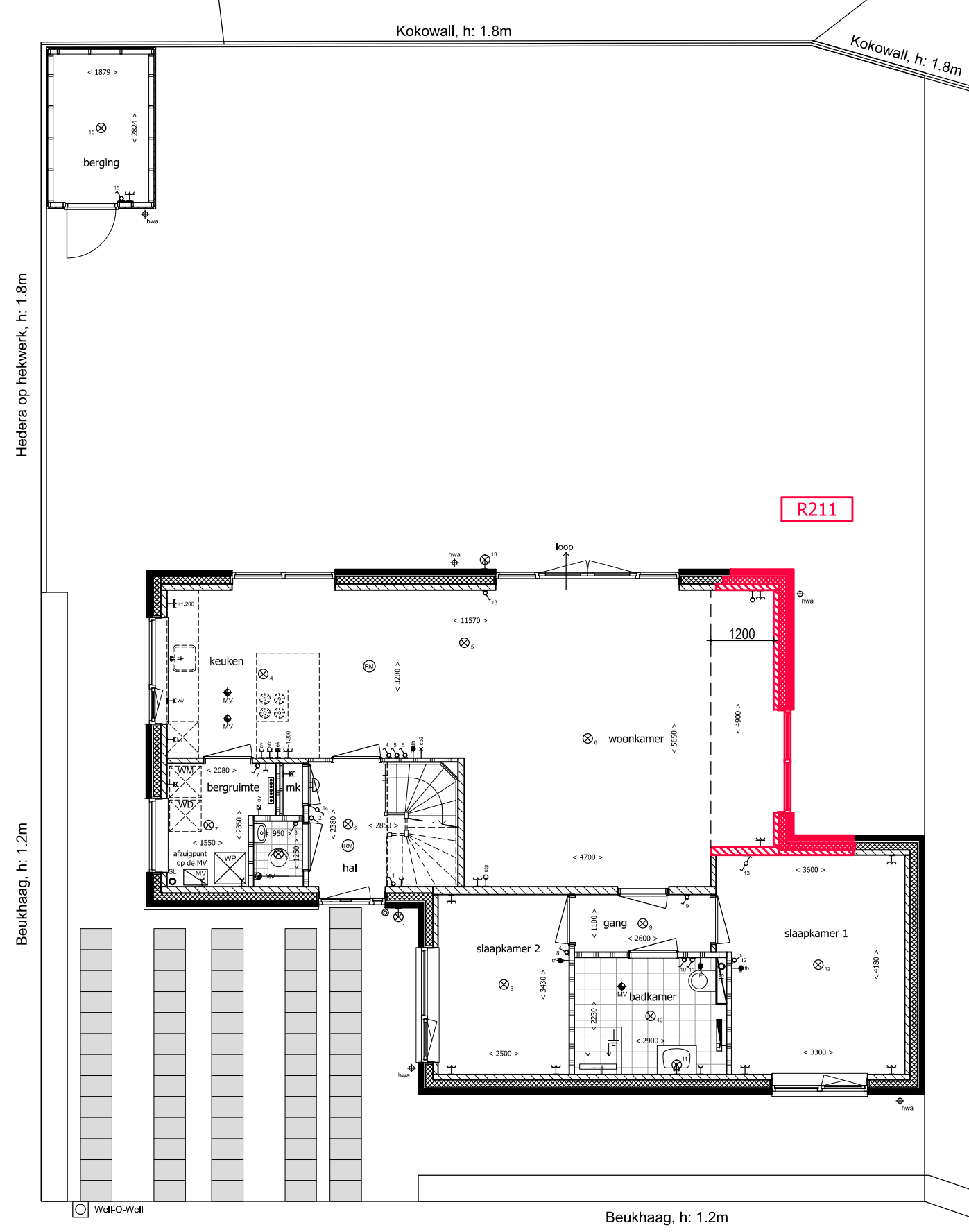

Begane grond

Bnr 12: uitbouw 1.200

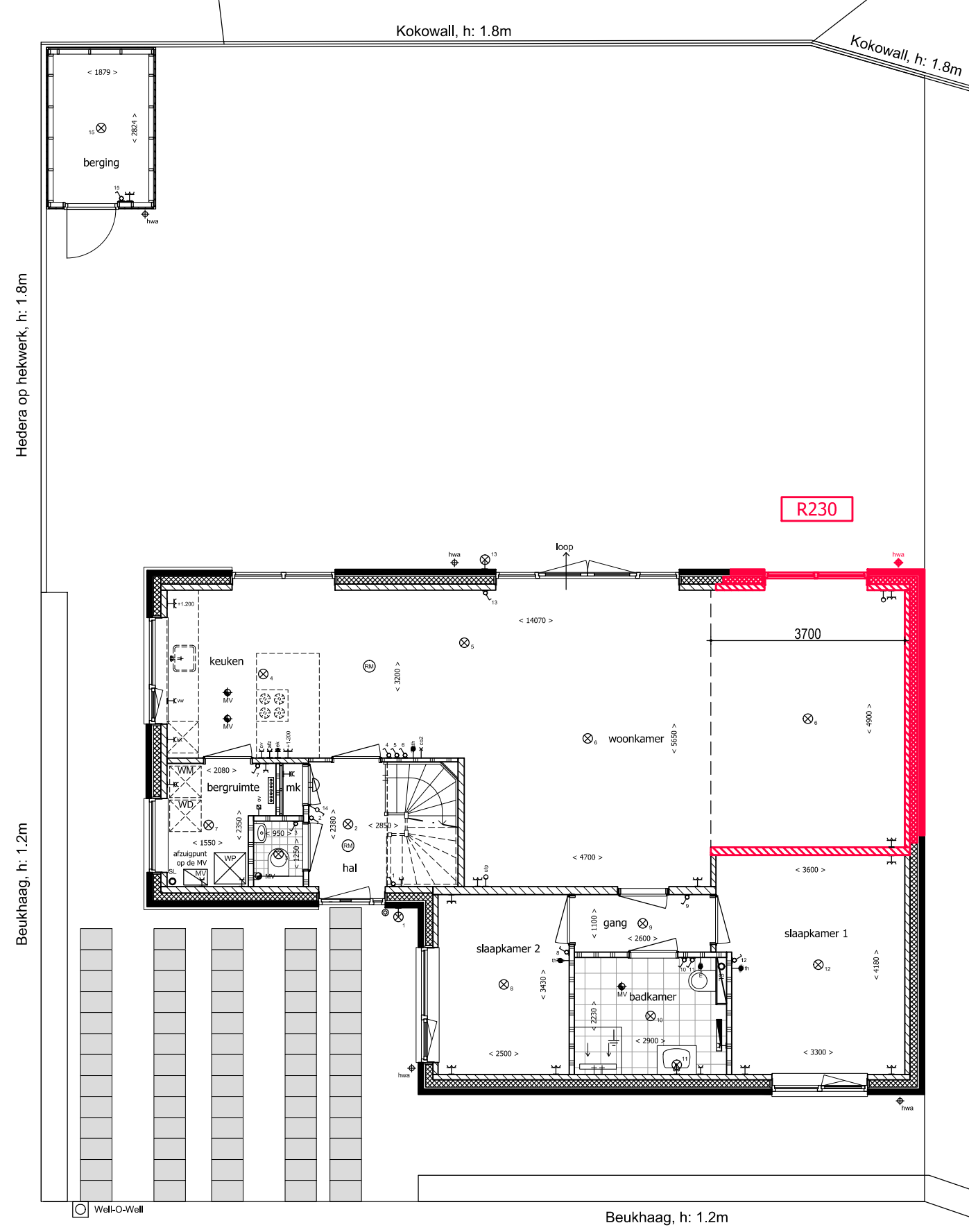

Bnr 12: uitbouw volledige diepte

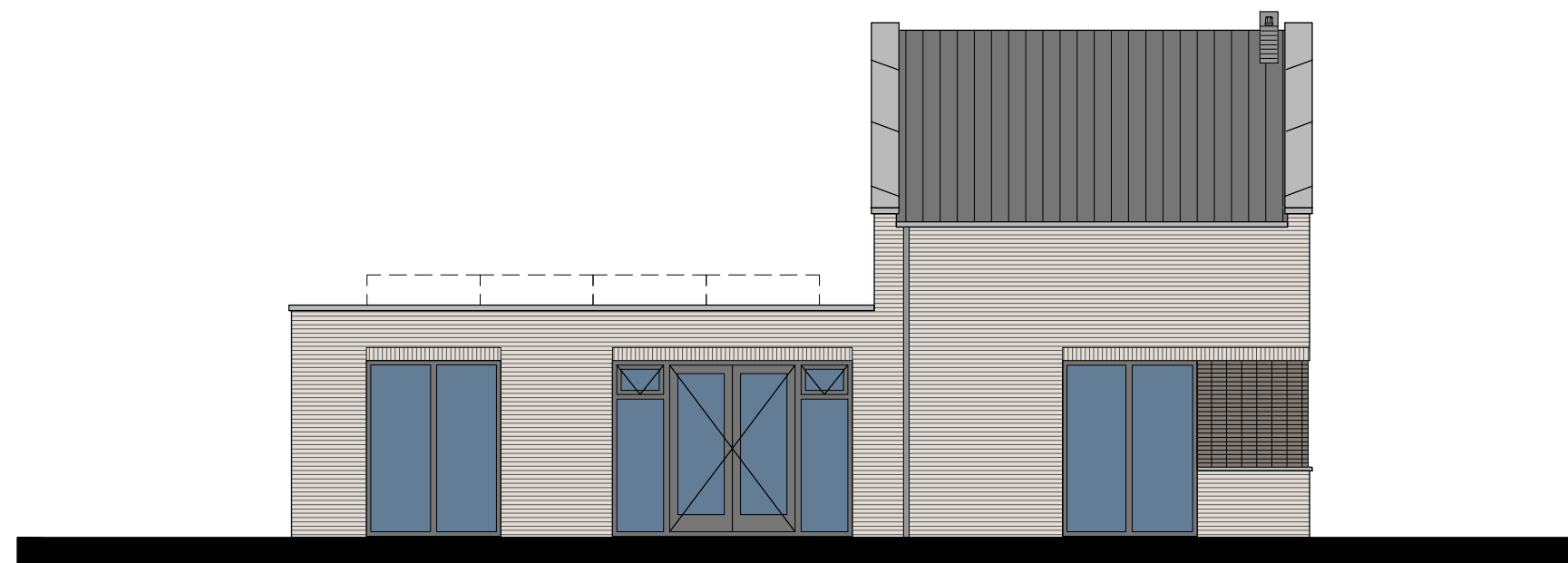

Achteraanzicht

R230

Bnr 12: uitbouw volledige diepte

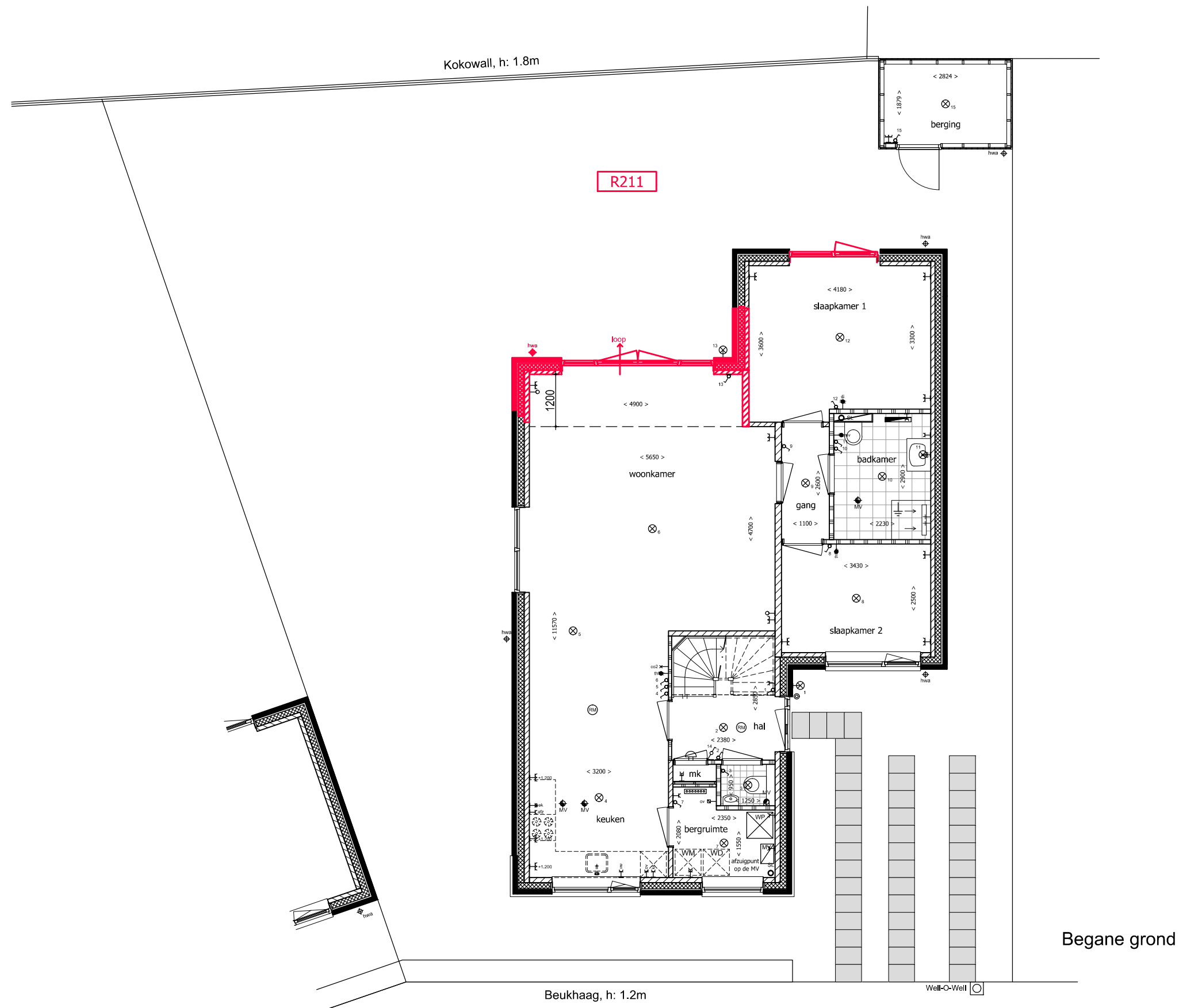

Begane grond

Kokowall, h: 1.8m

R211

Beukhaag, h: 1.2m

Bnr 13: uitbouw 1.200m

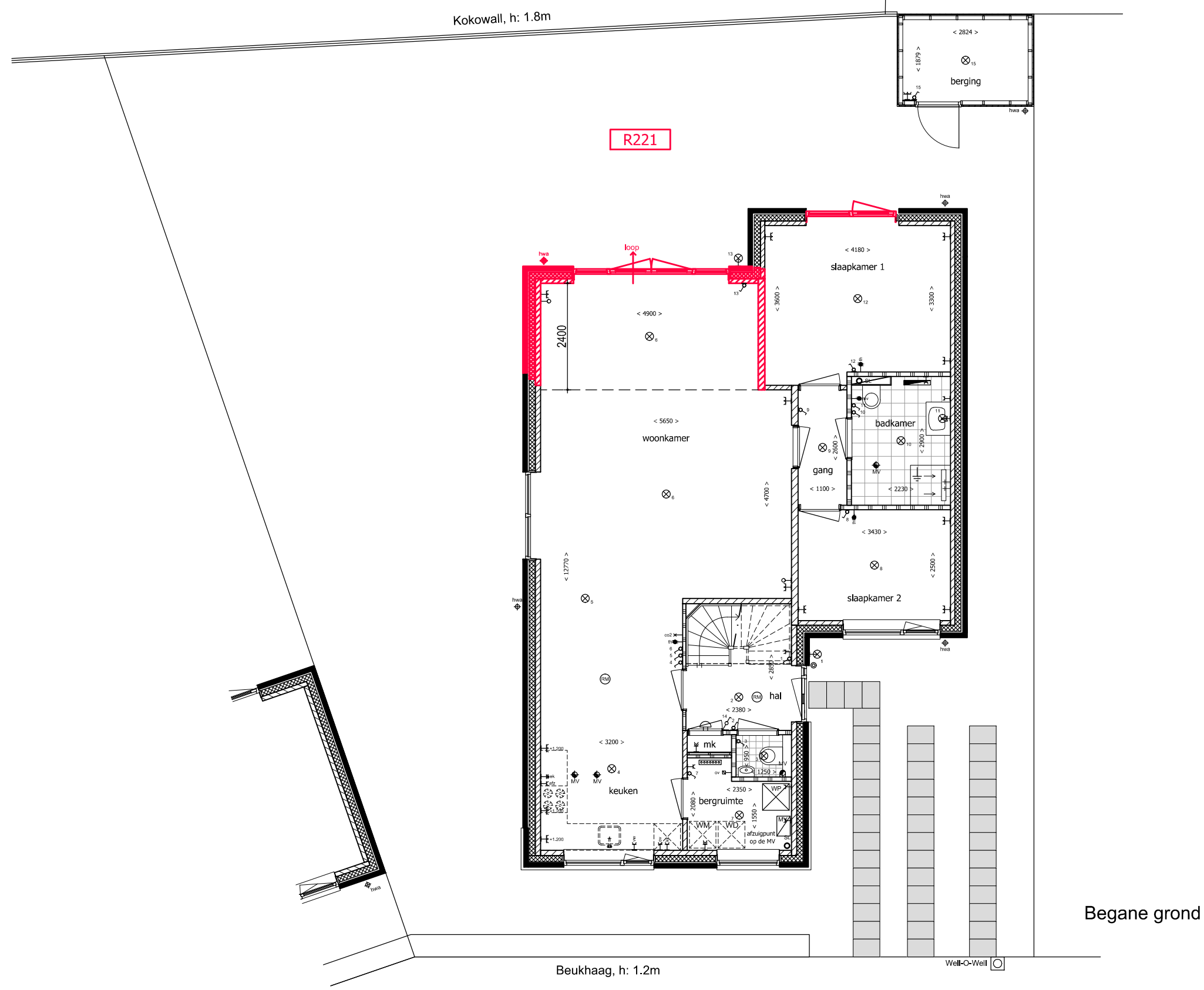

Begane grond

Beukhaag, h: 1.2m

R221

Kokowall, h: 1.8m

Bnr 13: uitbouw 2.400m

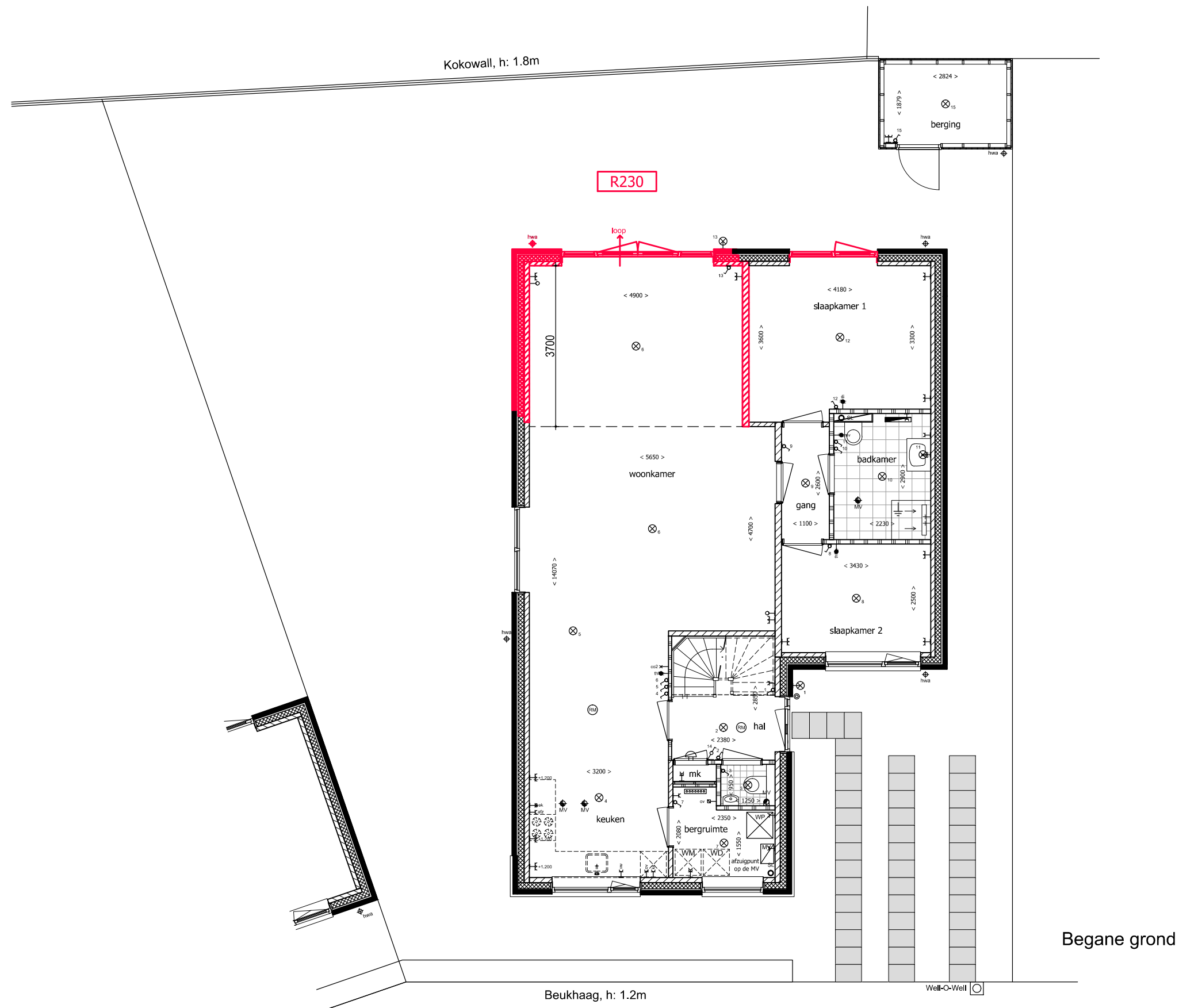

Begane grond

Beukhaag, h: 1.2m

Kokowall, h: 1.8m

R230

Bnr 13: uitbouw volledige diepte

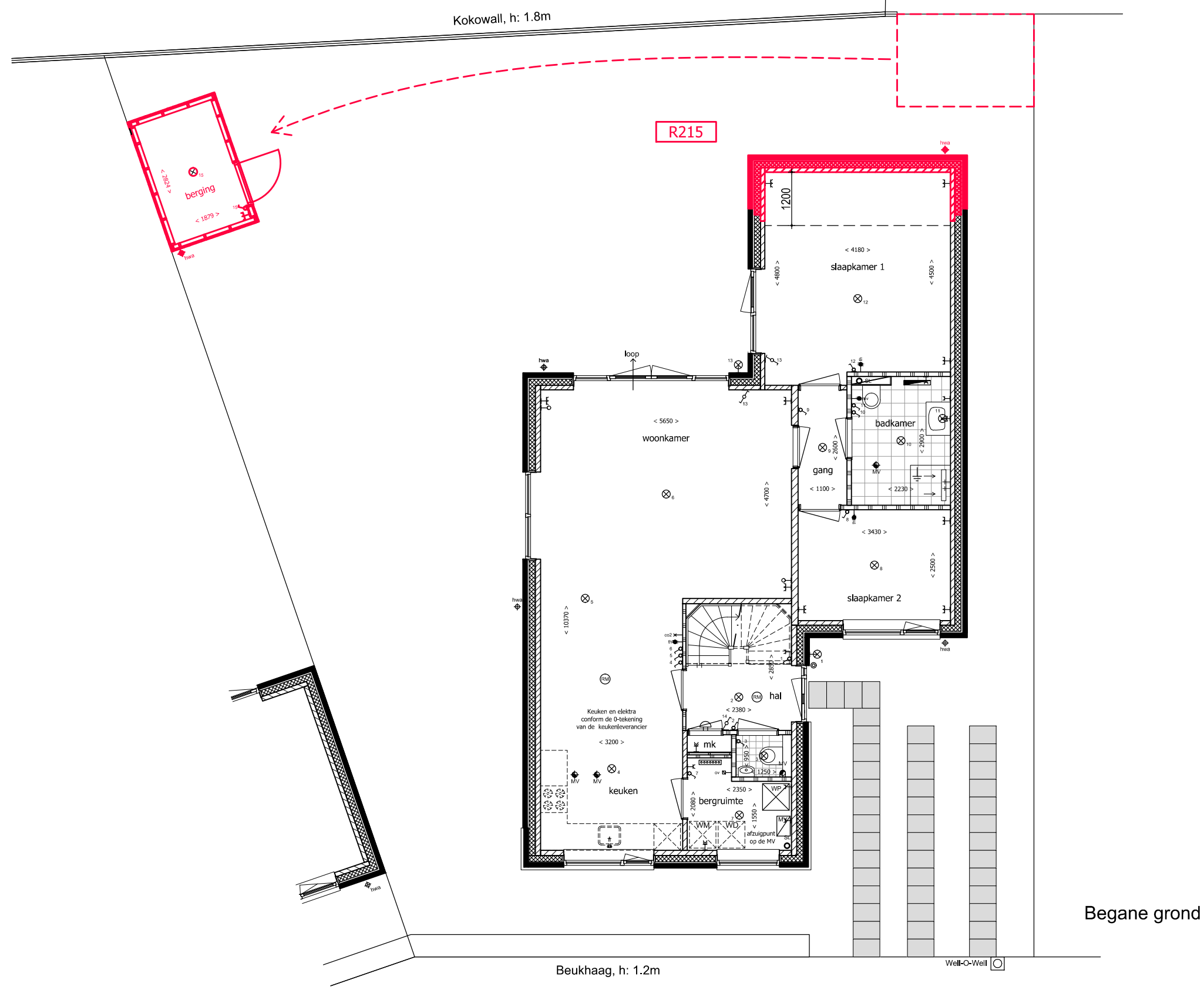

Bnr 13: uitbouw slaapkamer 1

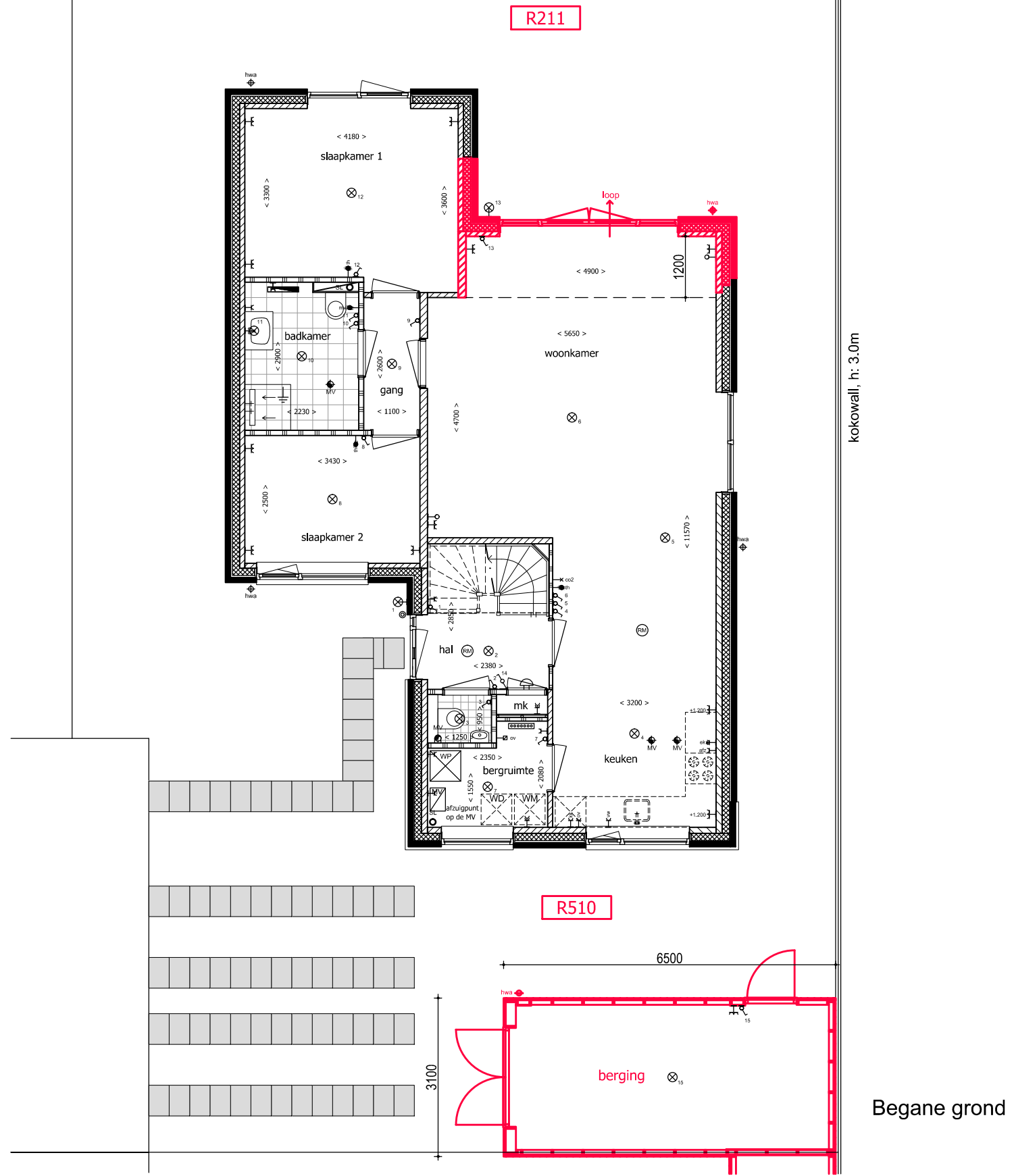

Bnr 14: uitbouw 1.200m en optie grotere berging

R221

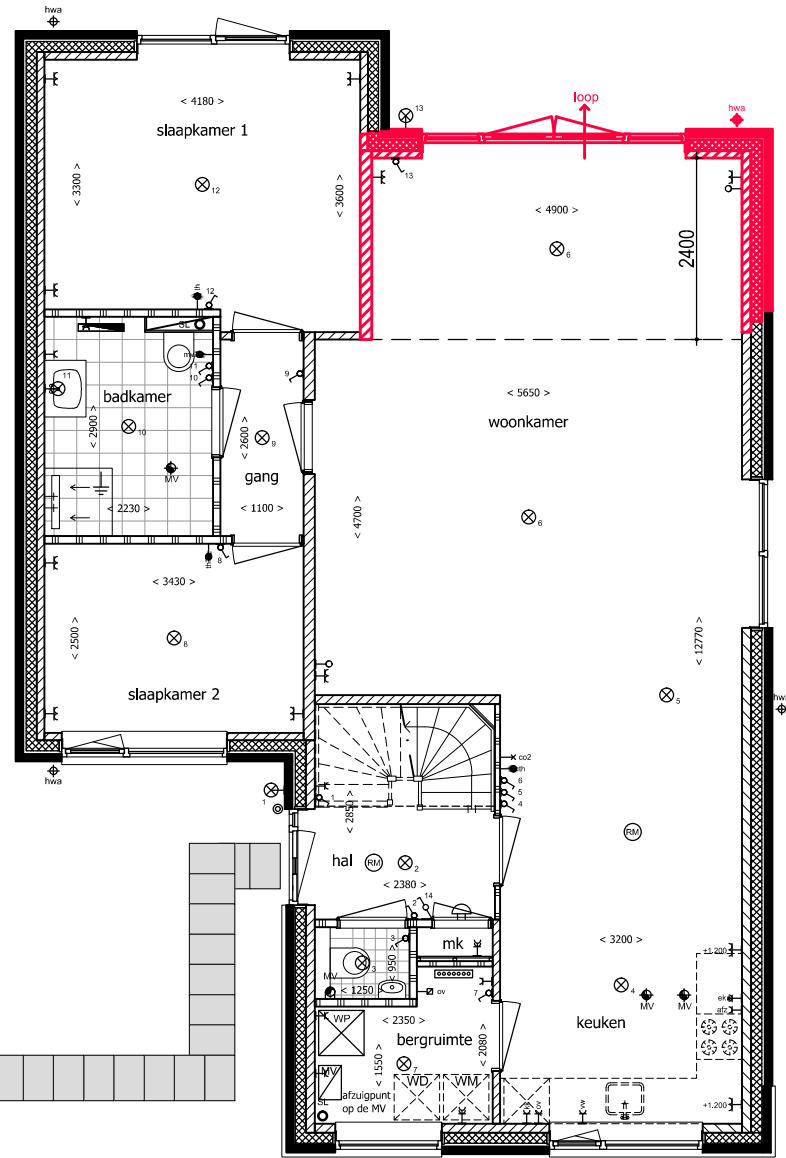

kokowall, n: 3.0m

Begane grond

Bnr 14: uitbouw 2.400m

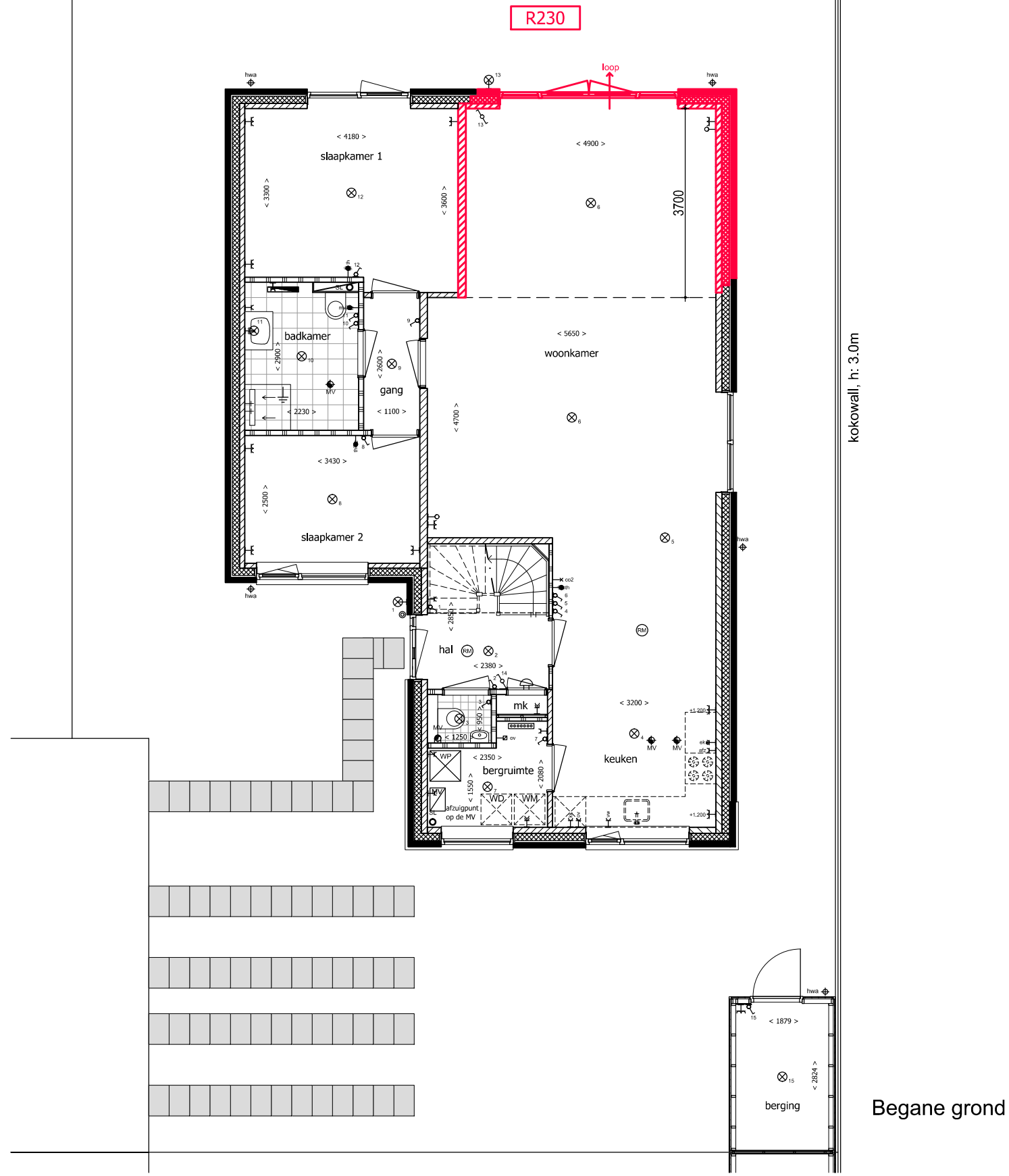

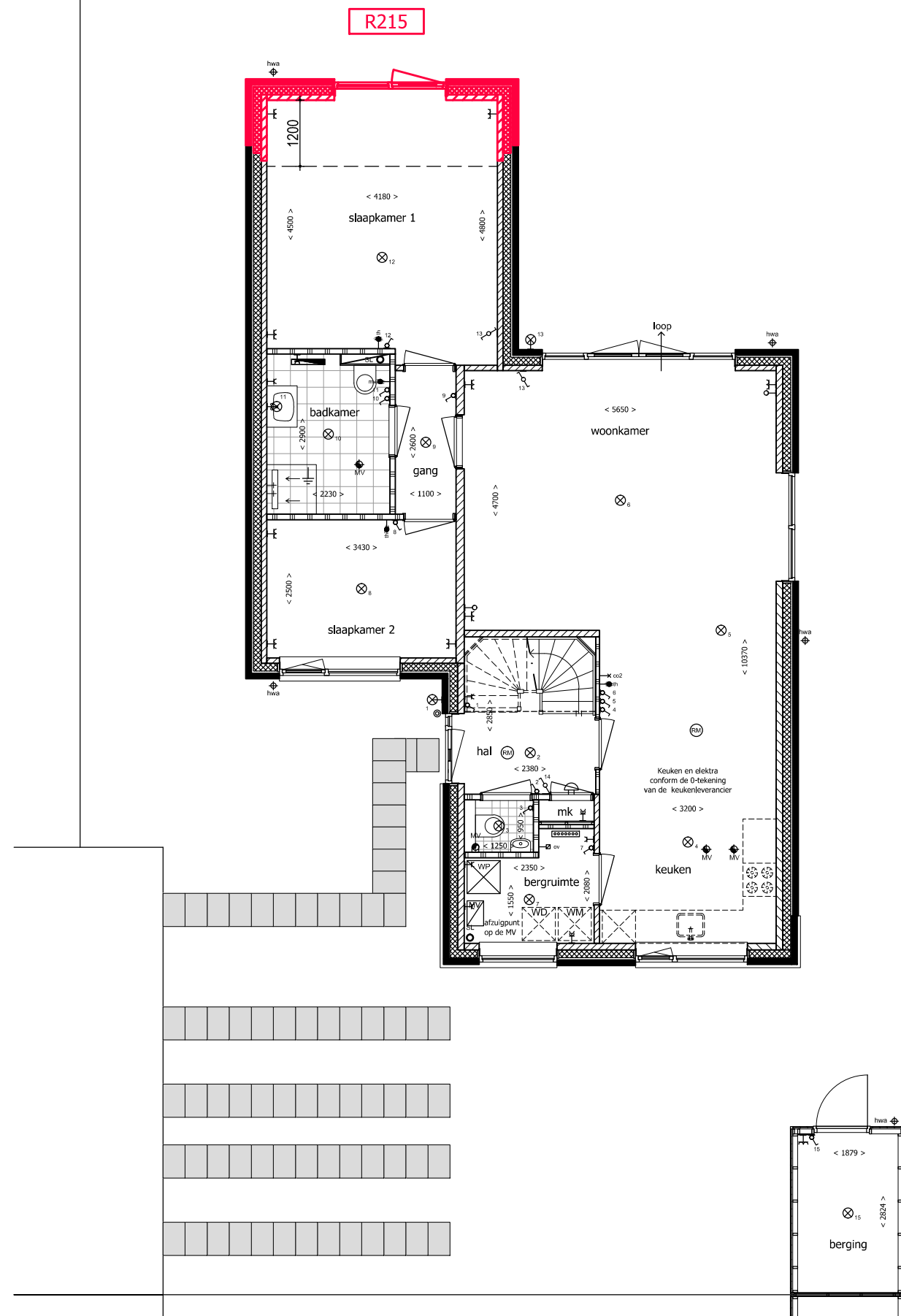

kokowall, n: 3.0m

Bnr 14: uitbouw slaapkamer 1

Begane grond

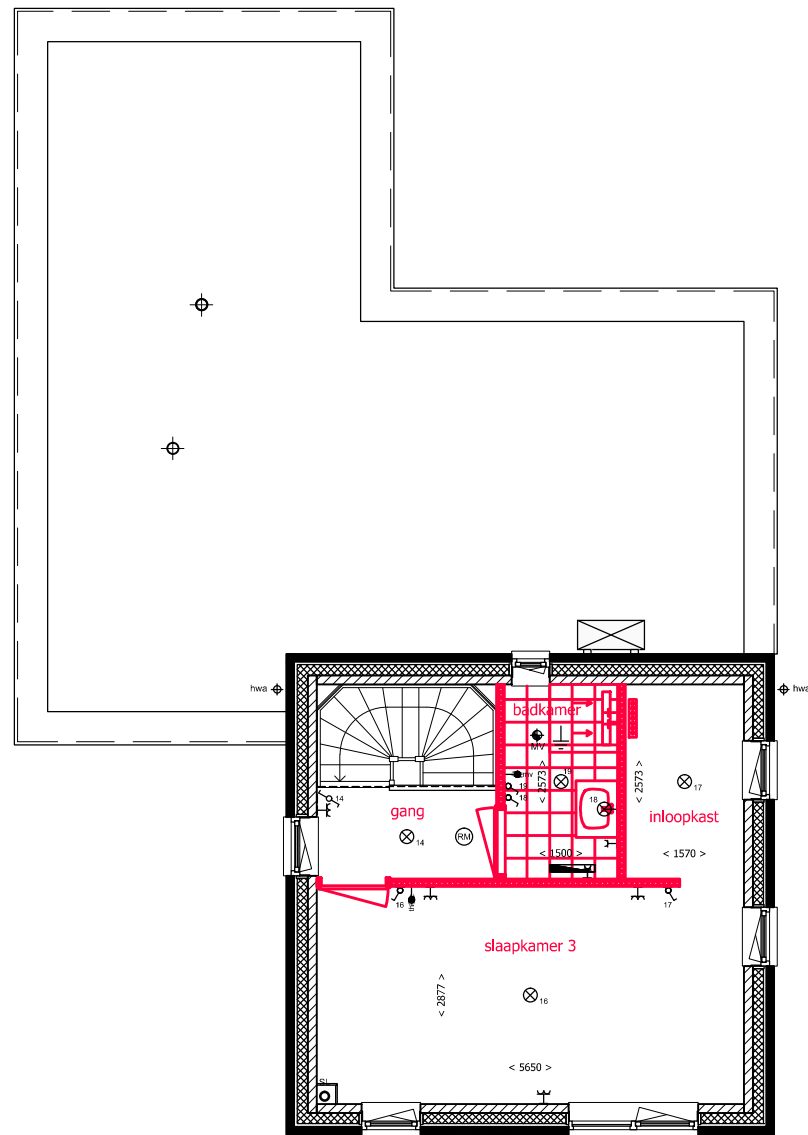

R669

Bnr 11: optie indeling 1e verdieping

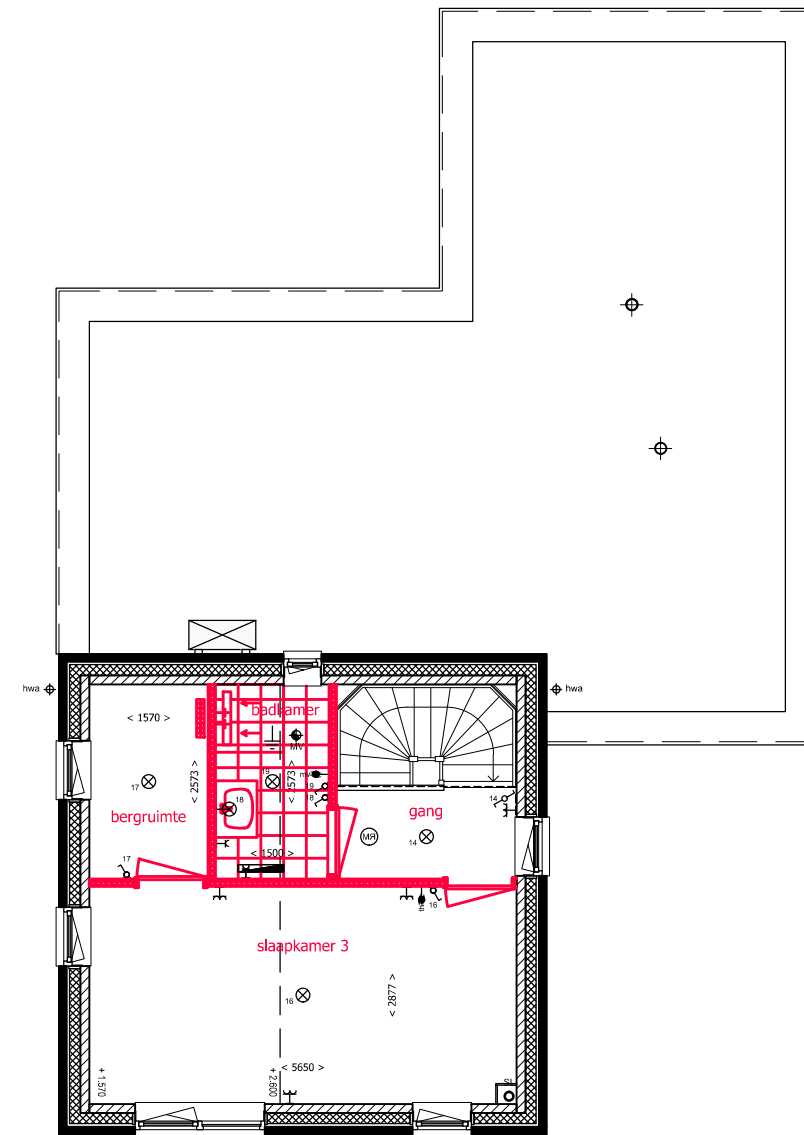

R669

Bnr 12, 13 en 14(gespiegeld): optie indeling 1e verdieping

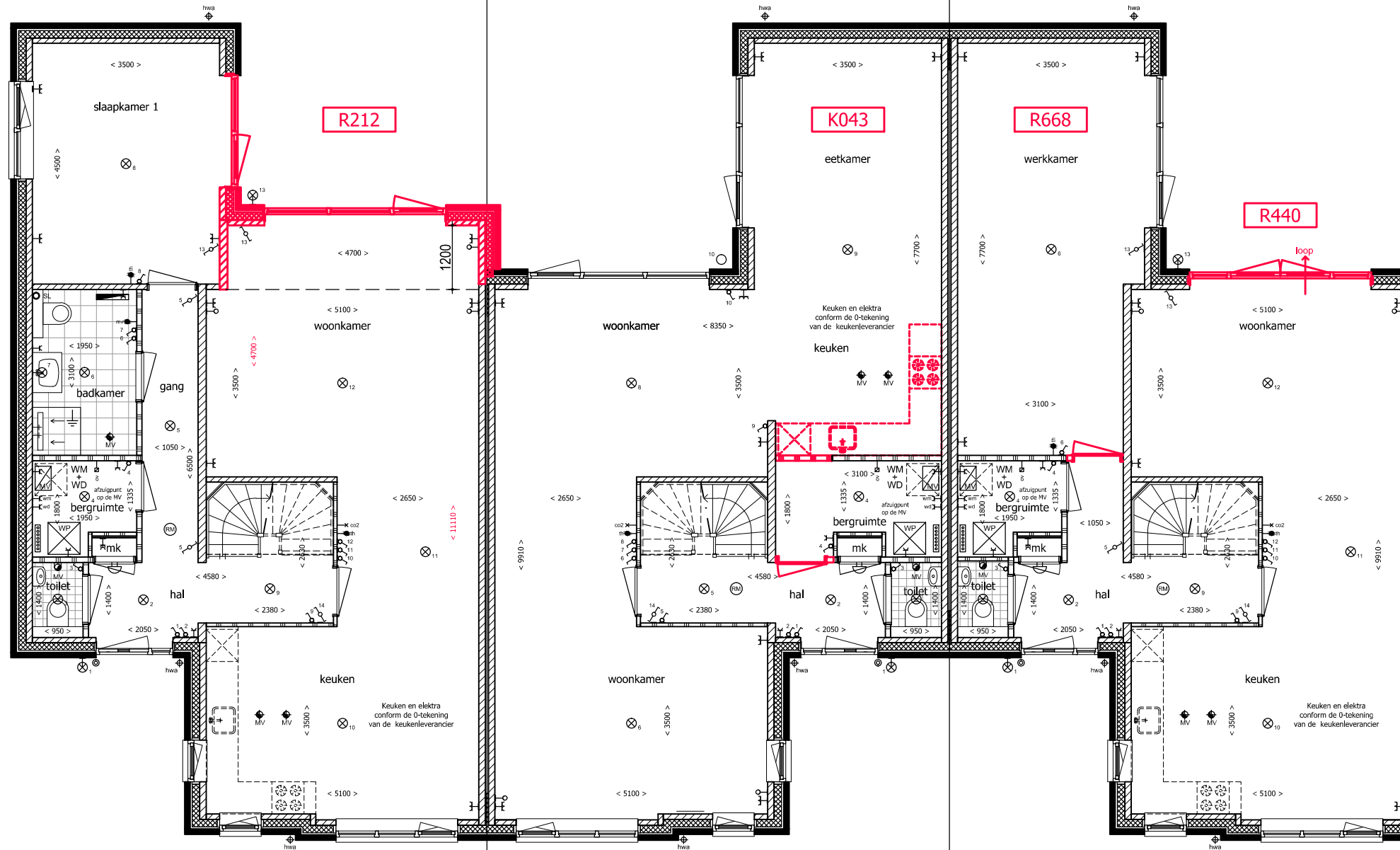

Optie uitbouw 1.200m

Optie keuken ipv de badkamer en slaapkamer

Optie werkkamer ipv de badkamer en slaapkamer



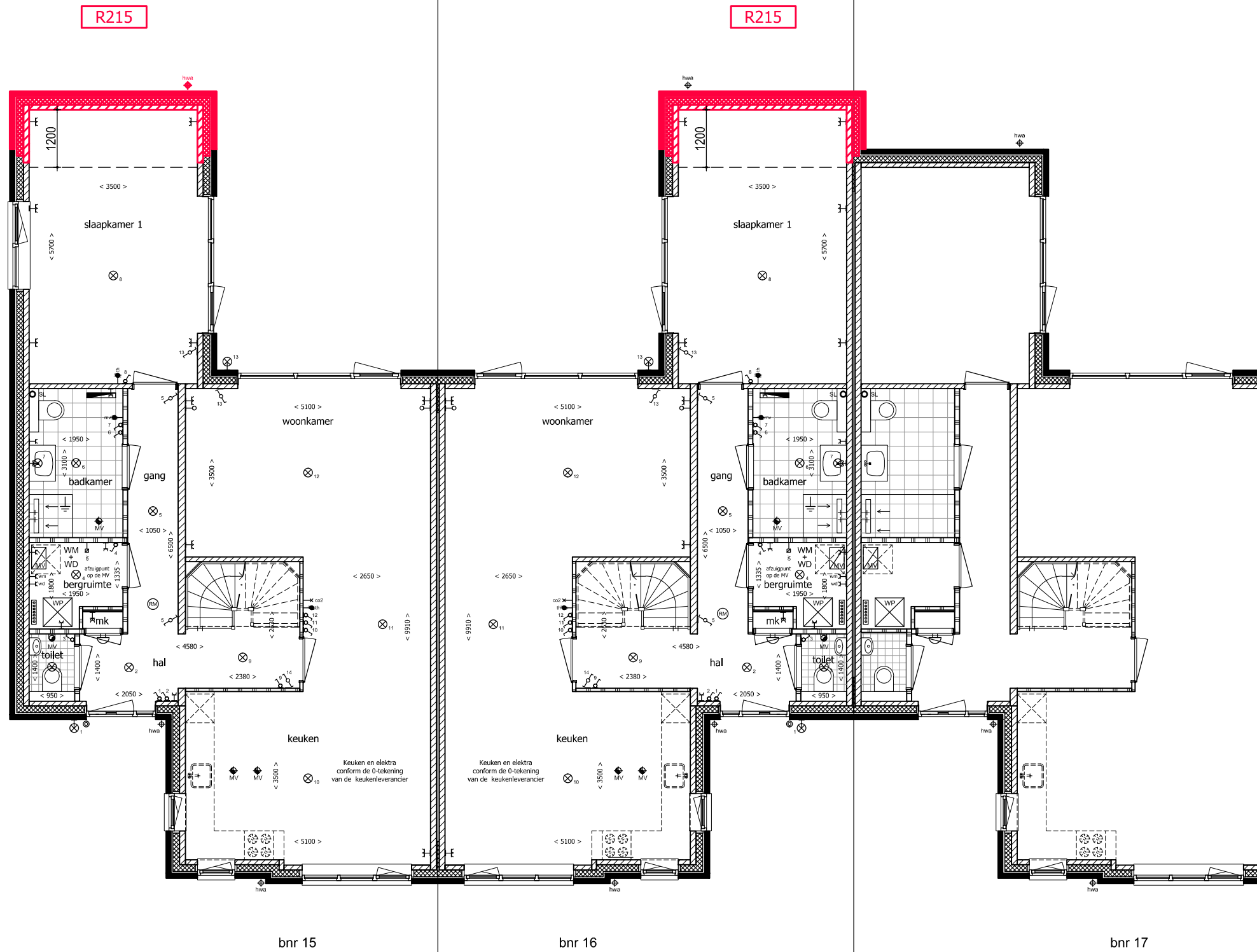

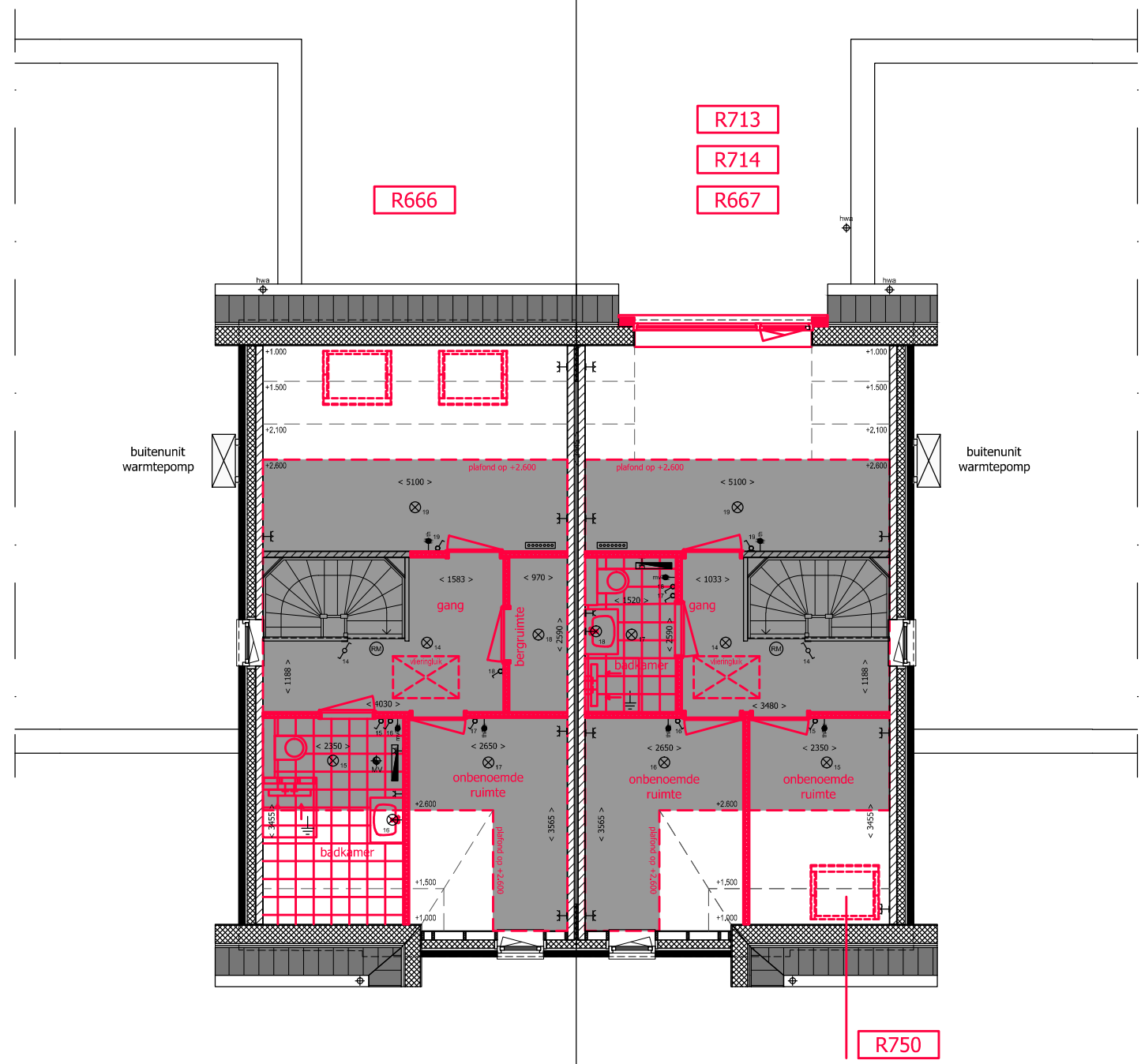

Optie indeling 1 met 2 grotere dakvensters

Optie indeling 2 en de optie dakkapel ipv de 2 grotere dakvensters

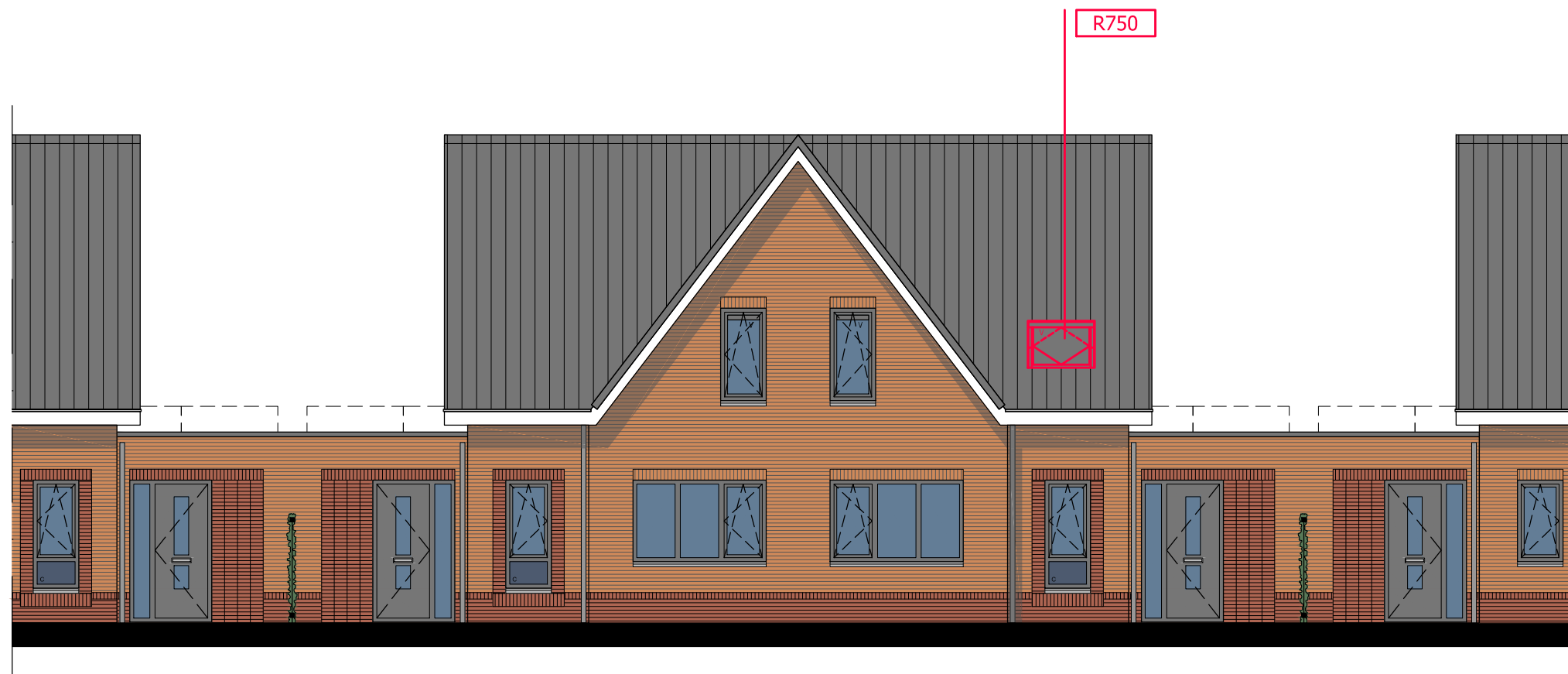

Vooraanzicht

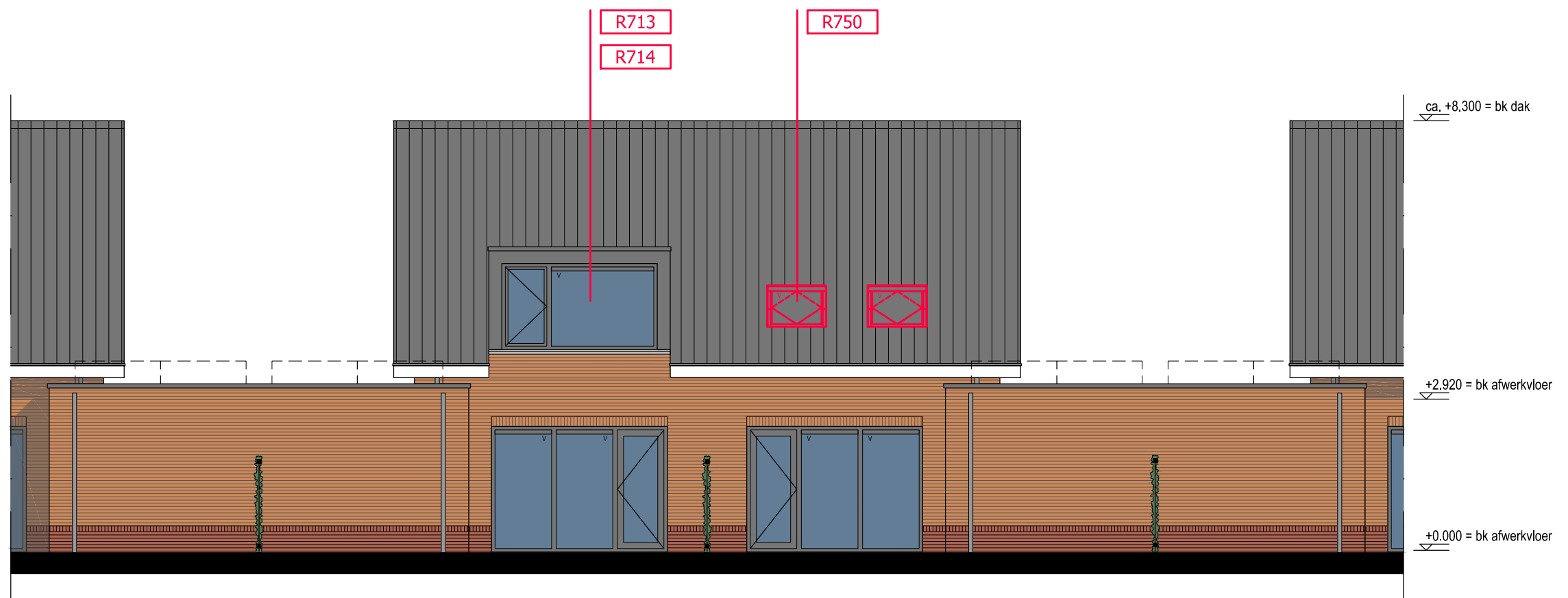

Achteraanzicht